

**Aus der Universitätsklinik  
für Zahn-, Mund- und Kieferheilkunde  
Tübingen  
Abteilung Poliklinik für Zahnärztliche Prothetik und Propädeutik  
Ärztlicher Direktor: Professor Dr. H. Weber**

**Sektion für Medizinische Werkstoffkunde und Technologie  
Leiter: Professor Dr. J. Geis-Gerstorfer**

**Rheological Characterization of  
Dental Waxes**

**Inaugural-Dissertation  
Zur Erlangung des Doktorgrades  
der Zahnheilkunde**

**der Medizinischen Fakultät  
der Eberhard-Karls-Universität  
zu Tübingen**

vorgelegt von  
**Kehao Zhang**  
aus  
**Henan, China**

**2004**

Dekan: Professor Dr. C. D. Claussen

1. Berichterstatter: Professor Dr. J. Geis-Gerstorfer

2. Berichterstatter: Professor Dr. F. Schick

**dedicated to my parents,  
my wife Zhaoxia, Luo  
and my son Boyuan, Zhang**



2.2.3.3	Temperature ramp oscillation test.....	34
2.3	Aims of the rheological resaerch of dental waxes .....	36
<b>3</b>	<b>Materials and Methods.....</b>	<b>37</b>
3.1	Materials.....	37
3.2	Preparation of wax samples .....	39
3.3	Rheometer .....	40
3.4	Rheological experiments.....	44
3.4.1	Amplitude sweep tests(CSD).....	45
3.4.2	Amplitude sweep tests (CSS).....	45
3.4.3	Temperature ramp oscillation tests.....	45
3.5	Statistical analysis.....	46
<b>4</b>	<b>Results and Discussions.....</b>	<b>47</b>
4.1	Shear dependent behaviors of dental waxes .....	47
4.1.1	Linear viscoelastic range .....	50
4.1.2	Dynamic modulus of dental waxes at each temperature.....	53
4.1.3	Shear dependent dynamic modulus .....	54
4.1.4	Gel-to-Sol transition .....	56
4.2	Effect of temperature on mechanical properties .....	60
4.2.1	Temperature dependence of the dynamic modulus .....	62
4.2.2	Gel point .....	64
<b>5</b>	<b>Conclusions .....</b>	<b>67</b>
<b>6</b>	<b>Summary .....</b>	<b>68</b>
<b>7</b>	<b>Appendix.....</b>	<b>71</b>
Appendix 7.1	Nomenclature.....	71

Appendix 7.2	Operating Procedures of UDS200.....	72
Appendix 7.3	Summarized Diagrams of Amplitude Sweep Tests (CSD) ...	74
7.3.1	Comparisons of each wax at all tested temperatures.....	74
7.3.2	Comparisons of all waxes at each temperature.....	78
Appendix 7.4	Summarized Diagrams of Amplitude Sweep Tests(CSS)...	81
7.4.1	Comparisons of each wax at all tested temperatures.....	81
7.4.2	Comparisons of all waxes at each temperature.....	85
Appendix 7.5	Typical Diagrams of Temperature Ramp Oscillation Tests..	88
Appendix 7.6	Results of amplitude sweep tests(CSD).....	92
Appendix 7.7	Results of amplitude sweep tests (CSS).....	96
<b>8</b>	<b>References.....</b>	<b>99</b>
<b>9</b>	<b>Acknowledgements.....</b>	<b>110</b>
<b>10</b>	<b>Lebenslauf.....</b>	<b>111</b>

## 1. Introduction

Many procedures in dentistry require the use of waxes [17]. The inescapable applications of waxes in dentistry stem from waxes' special combination of properties: plastic, low-melting, combustible, non-toxic, weak solids that can be readily shaped and molded. Waxes are used for some of the highest precision work in dentistry, as well as cruder tasks [20, 21, and 28]. They are used as patterns for inlays, crowns, pontics and partial and full dentures. Waxes are very useful for bite registration and can also be used to obtain impressions of edentulous areas. In the processing of restorative dentistry, waxes are very important for dentists and technicians. Precision mouldings to the shape desired are very important [28].

But waxes are complex mixtures [86]. They are organic polymers consisting of hydrocarbons and their derivatives (e.g. esters and alcohols). Dental waxes are blends of several ingredients, including natural waxes, synthetic waxes, natural resins, oil, fats, gums, and coloring agents. In the 'solid' state, waxes appear to consist of a variety of crystalline phases, some possibly solid solutions, as well as amorphous material [72]. All of the ingredients that go into the final wax blend or product play a role in determining the resulting properties. It is clear as a matter of fact that waxes exhibit very complex characteristics, especially the mechanical properties. Waxes have a melting range rather than a single, sharp melting temperature. Waxes have very high coefficients of thermal expansion, particularly around the melting range. The flow of waxes depends not only on the various forces, but also strongly on the temperature. Due to the residual stress, there will be a significant warpage happened to waxes. This is also called the "memory effect" [75]. These properties will be useful in the recommendation or selection of a wax. Meanwhile, the complex properties of waxes make it difficult to finish the very precise dentures [79].

As a viscoelastic material, rheological behaviour of waxes clearly must depend on the mechanical properties of the various phases, their proportions, and especially the operating temperature, which is in relation to their melting points

[61]. Supposedly, this allows properties to be manipulated to tailor the product to suit the task [71, 31]. The working environment provides other demands. Whether temperate or tropical, air conditioned or not, extra-oral mechanical modulus will be 'room temperature'-sensitive.

Therefore, the successful use of waxes must be with a full understanding of waxes' characteristics [28], especially the viscoelastic properties. The rheology of waxes is important in one sense or another for their applications, such as film formers, lubricants and modelling materials, the latter especially so in dentistry. Rheological measurements are valuable tools for us to understand the physicochemical nature of waxes.

Although the rheological properties of waxes are of considerable interest in dentistry, the only adopted method of characterizing them in this respect is arbitrary and uninterpretable [73]. Temperature analysis in any of its modern instrumental forms would appear to be a useful approach for beginning the characterization of waxes [109]. But there are very rare literatures, which concern the rheological characteristics of dental waxes, especially the temperature sensitivity. This investigation is concerned with the influences of temperature on the rheological characteristics of dental waxes.



## **2. Background**

### **2.1 Dental waxes**

#### **2.1.1 History**

Waxes, as one of the most versatile natural substances ever used by man, have already been used in people's life widely for a long time. The oldest wax used by peoples is the beeswax [18]. Over 60 million years ago, the insects wax production was already accepted by peoples as a diet source. At approximate 3000 B.C. in Egypt, people already used beeswax in the Egyptian Theben at the mummification process and for protective covering [76]. In Greek and Roman literatures, wax was also described in many applications: for sealing ships, binder matrix, protection coating at art objects, tablets, etc [76]. With the beginning of the classical chemistry in the 19th century, waxes were investigated more completely. Industry products were then developed gradually. The further development of the chemistry of the 20th century yielded a variety of new findings and products in the wax field. First synthetic liquid paraffins were produced according to the Fischer-Trop's procedure in 1935 [76]. Wax models used in connection with prosthetic work were first mentioned by Matthaeus Gottfried Purmann about 1700. It is supposed that the wax was carved to the desired shape, after which it was reproduced in bone or ivory by a craftsman [17].

At present, the versatile applications of waxes in dentistry are inescapable, whether metallic or polymeric, because of their special combination of properties: cheap, weak solids to be readily shaped and molded, plastic, low-melting point, easily carved, combustible, entirely organic composition (for burnout) and non-toxic [28]. For dentists and technicians, wax is a critical component in the creation of many restorations and procedures. There are still not many restorative procedures that can be carried out without the aid of waxes [18, 20]. The specific use of dental wax determines the physical

properties that are most desirable for a successful application. Traditionally, the physical properties, such as melting, thermal expansion, ductility etc, can be investigated using the normal methods. But waxes are viscoelastic and their rheological characteristics are extremely sensitive to the changes of temperature. Rheology measurements are valuable tools for us to understand the physicochemical nature of the waxes.

### **2.1.2 Main composition of dental waxes**

Wax is a very complex mixture of many different types of compounds. It can be simply defined as a substance that is solid at ambient temperature and when subjected to moderate temperatures, becomes a low viscosity liquid [18]. The relationship between wax composition and their behaviour has not yet been completely explored.

Waxes are organic polymers consisting of hydrocarbons and their derivatives (e.g. esters and alcohols). The average molecular weight of a wax blend is about 400 to 4,000, which is low compared with structural acrylic polymers. Waxes used in dentistry may be composed of several ingredients, including natural waxes, synthetic waxes, natural and synthetic resins, and other additions such as oil, fats, gums, fatty acids, and coloring agents of various types [75, 77]. The chemical components of both natural and synthetic waxes impart characteristics to the wax, which are of primary interest since the specific physical properties of a wax or wax blend determine its usefulness for intended application. So, by the blending of appropriate natural and synthetic waxes and resins and other additives, we can achieve the particular characteristics needed for the job at hand of each dental wax.

Natural waxes are of mineral (petroleum oil), plant, insect, or animal origin. The two principal groups of organic compounds contained in waxes are hydrocarbons and esters, though some waxes contain free alcohols and acids as well [75, 77]. Most mineral waxes have as their chief constituents

hydrocarbons ranging from 17 to over 44 carbon atoms, as shown in the following formula:

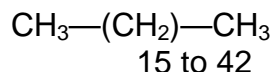

Plant and animal waxes contain considerable concentrations of esters, and carnauba (a plant wax) contains 85% alkyl esters of various kinds. The principal ester in beeswax is myricyl palmitate,

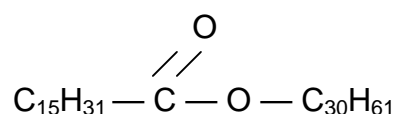

which is the reaction product of myricyl alcohol and palmitic acid. The plant and animal waxes also contain acid, alcohols, hydrocarbons, and resins [17].

It is apparent even from this brief description of the composition of natural waxes that they are complex combinations of organic compounds of reasonably high molecular weights. Therefore the dental manufactures must blend the particular batches of wax to obtain the properties desired for a particular application.

Paraffin Waxes, used in inlay and modeling waxes, are composed mainly of a complex mixture of chiefly straight saturated hydrocarbon chains possessing 26 to 30 carbon atoms of the methane series, together with a minor amount of amorphous or microcrystalline phases [75, 77]. It is relatively soft with a low melting range (50°C to 70°C), and the melting temperatures generally increase with increasing molecular weights. Paraffine waxes used in dentistry are refining waxes and have less than 0.5% oil, which can lower the melting temperature [17]. The paraffin waxes crystallize in the form of plate, needles, or malcrystals but generally are of plate type. Many hydrocarbon waxes undergo crystalline changes on cooling, and a transition from needles to plates occurs about 5°C to 8°C below their melting temperature. During solidification and cooling, there is a volumetric contraction that varies from 11% to 15%. This contraction is not

uniform throughout the temperature range from melting temperature to room temperature, since the wax is a mixture of hydrocarbons and the wax passes through transition points accompanied by changes in physical properties [17]. Unfortunately, the paraffin wax is likely to flake when it is trimmed, and it does not present a smooth, glossy surface, which is desirable requisite for an inlay wax. Consequently, other waxes and natural resins are added as modifying agents [75].

Beeswax is a primary insect wax used in dentistry, obtained from honeycombs. It is a complex mixture of esters consisting mainly of myricyl palmitate plus saturated and unsaturated hydrocarbons and high molecular weight organic acids. It has an intermediate melting range (60°C to 70°C) [75]. It is a brittle material at room temperature but becomes plastic at body temperature. It is used to modify the properties of paraffin waxes because of its desirable flow properties at oral temperature, and in dentistry it is the main component in sticky wax. Kotsiomiti and McCabe[58] studied the mixture of paraffin and beeswax. The flow of paraffin was significantly reduced by the addition of beeswax. The significant reduction of the flow of paraffin did occur when 20-30% beeswax was added, but not by as much as 50%, reported by Mc Crorie [70].

Carnauba waxes come from a fine powder on the leaves of certain tropical palms. They are composed of straight-chain esters, alcohols, acids, and hydrocarbons. They are characterized by quite high hardness, toughness, brittleness, and high melting points from 65°C to 90°C [75]. They possess the outstanding quality of increasing the melting range and hardness of paraffin waxes. That is to say they can be added to tough paraffin wax and to decrease the flow at mouth temperature. For example, the addition of 10% of carnauba wax to paraffin wax with a melting range of 20°C will increase the melting range to 46°C [17].

Microcrystalline waxes are produced from a combination of heavy lube distillates and residual oils in the petroleum industry or from crude oil tank bottoms. Microcrystalline waxes are mixtures of solid, purified, mainly branched-chain, saturated microcrystalline hydrocarbons, monocyclic and polycyclic compounds as well as normal alkanes. They have higher molecular weights, with the average molecule containing 41 to 50 carbon atoms. They differ from paraffin waxes in that they have poorly defined, extremely smaller crystalline structure, darker color, and generally higher viscosity and melting range (65°C to 90°C)[75]. They are sometimes referred to as amorphous wax. As their name suggests, the microcrystalline waxes crystallize in small plates and are tougher and more flexible than the paraffin waxes [17]. Microcrystalline waxes tend to vary much more widely than paraffin waxes with regard to physical characteristics. They can range from being soft and tacky to being hard and brittle, depending on the compositional balance. They are low in odor and have a sticky feel. The microcrystalline waxes have an affinity for oils, and the hardness and tackiness may be altered by the addition of oils. It is of particular interest that microcrystalline waxes have less volumetric change during solidification than paraffin waxes have [17]. They are added to modify the softening and melting ranges of the wax and to make it behave in a harder and more brittle or softer and more pliable manner. They also serve to reduce stresses that occur on cooling [79].

The use of synthetic waxes and resins, though on the increase, is still limited in dental formulations, and the natural waxes continue to be the primary components [20, 87]. Synthetic waxes are complex organic compounds of varied chemical compositions [17]. They have specific melting points and are blended with natural waxes. Although differing chemically from natural waxes, synthetic waxes possess certain physical properties, such as melting temperature or hardness. Natural waxes vary more depending on their sources and need to be monitored more for properties than synthetic waxes, which are more uniform in composition. Synthetic waxes may differ from natural waxes in certain characteristics because of the high degree of refinement they possess,

in contrast to the contamination that is frequently present in waxes from natural sources. Low-molecular-weight polyethylene is an example of a synthetic wax [75].

### **2.1.3 Classification of dental waxes**

According to use and application, wax products applied in dentistry can be broadly classified into the following categories: pattern waxes, processing waxes, and impression waxes [17].

Pattern waxes include inlay, resin, casting wax and baseplate waxes. They are used to form the general predetermined size and contour of an artificial dental restoration, which is to be constructed of a more durable material. All pattern waxes have two major qualities, thermal change in dimension and tendency to warp or distort on standing, which create serious problems in their use whether an inlay, a crown, or a complete denture is being constructed. Inlay waxes are used to make inlays, crowns, and pontics replicas for the lost wax casting technique [2]. They consist essentially of natural and synthetic waxes, resins and hydrocarbons of the paraffin series. Type □ inlay waxes are hard and used for the direct inlay technique. Type □ inlay waxes are soft and are used for preparing replicas on dies and models. Sometimes, inlay waxes can also be used for the attachment of miscellaneous parts. Pattern resins are characterized by higher strength and resistance to flow than waxes, good dimensional stability, and burnout with out residue. Casting waxes are used for thin section of certain removable and fixed partial denture patterns. They are particularly convenient in the preparation of copyings or clasps requiring uniformly thin regions. Base plate wax is used to establish the vertical dimension, the plane of occlusion, and the construction of full denture patterns in the technique for complete denture restoration. The ANSI/ADA has established a specification that includes three type of base plate wax [1]: Type □ is a soft and is for veneers and contours. Type □ is a medium hardness, designed for temperature weather for patterns to be tried in the mouth. Type □ is the hardest base plate wax and is for patterns to be tried in the mouth in hot

weather. The hardness is based on the amount of flow the wax shows at 45°C. Base plate wax is also used as a mould for the construction of provisional fixed partial dentures, and has some applications in orthodontics [75].

Processing waxes are used primarily as auxiliary aids in the construction of restorations and appliances, both clinically and in the laboratory. They include boxing wax, beading wax, sticky wax, carding, blockout wax, white, and utility waxes. They perform numerous tasks that simplify many dental procedures in such operations as denture construction or soldering. Boxing waxes are used to form a wax box around an impression for pouring casts. It is also used to fabricate replacement pontics for provisional fixed partial dentures. Carding wax is used for attaching parts and in some soldering techniques. Blockout wax is used to fill voids and undercuts for removable partial denture fabrication. White wax is used for making patterns to simulate a veneer facing. Utility wax has miscellaneous applications for various laboratory procedures [75, 79]. Sticky wax is a mixture intended to be quite rigid and brittle at room temperature. Such a material is sticky when melted and are applied in the molten state and set rapidly to form a strong bond between the wax parts being assembled [23, 24, 28, 74, and 79]. It is used to join materials temporarily to facilitate the holding in position of objects while other processes are applied. It is even be used as a repair agent for broken plaster models or impressions. For this to be effective the melting point is necessarily rather higher than most other dental waxes at 65°C or so.

Impression waxes are soft waxes used exhibiting high flow and distort on withdrawal from undercuts. They are limited to be used in the nonundercut edentulous regions of the mouth, and are generally used in combination with other impression materials such as polysulfide rubber, zinc oxide-eugenol, or dental impression compound. Corrective waxes are used to record detail and displace selected regions of soft tissue of a dental arch in edentulous impressions [32, 58]. They appear to be formulated from hydrocarbon waxes such as paraffin and ceresin with synthetic waxes. These kinds waxes exhibit

100% flow at 37°C as measured by penetration and are subject to distortion during removal from the mouth [82]. Bite waxes are used in certain prosthetic techniques; a typical use of bite waxes is bite registration.

#### **2.1.4 Physical properties of dental waxes**

Waxes may consist of both crystalline and amorphous components, each with a distribution of molecular weights. They will have different physical and mechanical properties and play a role in determining the resulting properties of waxes [28, 75]. Although one or few compounds may dominate, they never approach purity [28]. Therefore, the characteristic properties of waxes are very complicated.

##### **2.1.4.1 General physical properties**

With complicated components, waxes have a melting range rather than a single, sharp melting temperature. Generally the mixture has a wider melting range than either component wax [23]. It is of primary importance in designing a commercial wax product because this, and particularly the lower limit, controls the applicability of a given wax formulation in a particular function [28]. But it is impossible to obtain precise values for the top and bottom of the melting range merely by studying ordinary cooling curves, because of the strong chemical similarities of components. There are several methods for the determination of the melting point of waxes. The two commonly used are Ring and Ball Softening Point and Ubelhode Drop Melt Point. These two methods yield different results, with the Ring and Ball method generally yielding slightly lower value [74]. The softening point indicates the temperature at which the wax changes from a solid to a semi-liquid. It is very important for allowing greater latitude in operation, avoiding complete melting for slight overheating and permitting moulding to the exact shape without it becoming too rigid too soon it cools [28]. Waxes composed mainly of hydrocarbons soften at low temperatures and over large temperature ranges [21]. The rate of temperature change during solidification and the presence of discontinuities in the cooling curves below solidification



indicate the extent of crystallinity present in a wax. The more crystalline the wax, the greater is the internal stress in a wax specimen when manipulated below these temperatures. For beeswax, the rate of temperature change during solidification is much greater than that of paraffin during solidification [21]. The use of microcrystalline waxes which have minute crystals and less orientation is preferred, and these should produce a more stable wax.

Like other materials, waxes expand when subjected to a rise in temperature and contract as the temperature is decreased. In general, dental waxes and their components have the largest coefficient of thermal expansion of any material used in restorative dentistry, particularly around the melting range [84]. Waxes are partly elastic in behaviour and tend to return to their original shape after deformation. Resultant dimensional changes may produce poor-fittings if not balanced by compensating factors of mould expansion [28]. Reiber, Th and Hupfauf, S. [85] tested three bite registration waxes (Kerr No.8-wax, Beauty Pink Hardwax and Aluwax) for their thermic dimensional behaviour under several heating and cooling conditions. The recommendations for clinical application are as follows: They should not be heated more than necessary for achieving a sufficiently plastic quality for use. It should be stored in ice water to be resistant enough to deformation during the model mounting.

The ductility of a wax sample increases as the temperature is increased. The ductility of a blended wax is greatly influenced by the distribution of the melting temperature of the component waxes. In general, waxes with lower melting temperatures have a greater ductility at any temperature than those with higher melting temperatures have [28].

### 2.1.4.2 The mechanical properties

The mechanical properties of waxes play a vital part in the dental procedures. Patterns must be sufficiently tough to resist breakage during assembly and must not distort if dimensional tolerances are to be maintained. Compared to other materials, dental waxes have lower mechanical properties, and these properties are strongly dependent on temperature. The strength properties of natural waxes at room temperature were in the decreasing order of carnauba, paraffin, and beeswax. Increases in temperature result in decreases in mechanical properties of dental waxes [25].

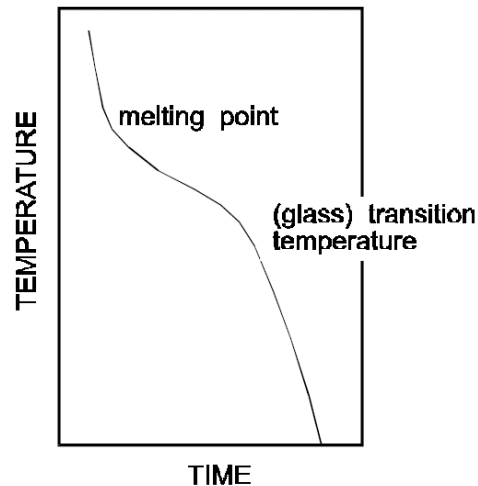

Figure 1 Transition temperature and melting point of waxes [84]

The time-temperature cooling curve for a typical dental wax is not indicative of a fully crystalline material. The curve in Figure 1 features two inflections; the upper inflection indicates the melting point and the lower inflection the transition temperature. At temperature above the melting point, the crystallites have melted and the wax is fully fluid. At temperature below the transition temperature the wax is rigid and cannot easily be moulded. At temperatures between the melting point and the transition temperature, the wax is partly fluid and partly solid, i.e. it is VISCOELASTIC [84]. Attempting to shape the wax at temperature below the melting point will not result in full and permanent

deformation. Thus, to maximise flow and minimise any possible subsequent stressrelief, all moulding of wax should, ideally, be carried out above the melting point, but at least above the transition temperature. However adapting wax at too high a temperature may result in excessive thermal contraction and dimensional inaccuracy.

Wax has a tendency to flow [32]. Flow of waxes is clearly important, not only as part of the deliberate moulding process but also an undesirable aspect after the pattern or impression has been made. Flow results from the slippage of wax molecules over each other. It is a measure of a wax's ability to deform under light forces and is analogous to creep. Generally, the rheological principles remain valid in wax systems [28].

A direct relationship was found between the flow of the wax and the casting shrinkage that could affect the precision fit of the final restoration [53]. The plastic deformation or percentage of flow increases with increasing temperature and under stresses (force) [32]. The most important factor which determines the extent of flow for a given wax is temperature. At a temperature close to its melting range, a wax may flow under its own weight. In liquids, flow is measured by viscosity. In solids, flow is measured by the degree of plastic deformation over a fixed period of time [75].

Usually, maximum flow is required while the adaptation is being carried out, while minimum flow is desirable when the process is complete. The magnitude of flow will influence the degree of setting expansion of dental waxes [52]. The amount of flow required from a wax depends on its use [22, 88]. Type□direct inlay technique waxes need to flow well to reproduce details of the cavity preparation[2, 4]. However, when the wax is cooled to the oral temperature, flow must be minimized to reduce distortion when the pattern is removed.

Ito et al [53] investigated the relationship between flow characteristics, bending strength, and softening temperature of paraffin and dental inlay waxes to

casting shrinkage. They found that the casting shrinkage decreased as the flow of the wax pattern increased. It is important to select the type of wax with the most desirable properties for the margin and the occlusal portions. They also concluded that, to accurately fabricate castings, it is necessary to understand the physical properties of the chosen waxes.

Residual stress exists in the completed pattern, regardless of the method used to prepare a wax pattern. For viscoelastic waxes, some slow deformation must occur, even in the absence of external stress or elevated temperature. The warpage is due to the residual stresses which result from the heating of wax specimens formed under compression or tension. It will result in dimensional inaccuracy and is undesirable. The longer the wax pattern is left before being invested, the greater the distortion that must be result [16, 28]. The effects are minimized by storing the shaped wax for the minimum possible period (eg. the wax pattern for an inlay) and at reduced temperature.

#### **2.1.5 Rheological researches on dental waxes**

Waxes are used for some of the highest precision work in dentistry, as well as cruder tasks, yet they have the worst thermal expansion coefficients of all in dentistry [12, 16, 19, 24, 79]. Where such dimensional changes are constrained, flow must ensue. Worse, expansion depends on the previous stress history [19]. This is attributable to the problem one of rheology. So, the rheological properties of waxes are of considerable interest in dentistry, especially their viscoelastic properties in dependence on temperatures.

But there has been relatively few fundamental studies about dental waxes in recent years. The rheological behaviour of dental waxes is not well documented in the literatures. The research is more likely to be about practical applications of wax patterns, especially for fixed and removable prosthodontic uses [32]. That wax rheology has received very little attention is presumably due to the difficulties associated with their handling, the measured viscosity of a number of

waxes having been shown to be highly sensitive to the stress history of the specimen [102]. The properties of waxes are such that conventional measuring method is essentially impossible [72].

Traditionally, the mechanical behavior of dental waxes is temperature sensitive, depending on composition and number of phases [62]. Supposedly, this allows properties to be manipulated to adapt the product to the task [31, 71]. The working environment provides other demands, especially the temperature condition. The rheological behaviors of waxes will seriously influence the accuracy of the finished products. But there exists no rigorous specification, and few attempts has been made to characterize dental waxes rheologically. Despite the “urgent” need for “standardized testing methods” being recognized as long ago as 1941 [54], waxes are mentioned in only two of the International Organization for Standardization’s (ISO) many standards, neither in a rheological context. No other standardization work has been concerned in other fields. American Dental Association (ADA) Specification No. 4 [2], adopted by the ISO [ 49 ], refers to Dental Inlay Casting Waxes. It has been revised a number of times [8, 89] since its introduction [91]. Dental baseplate/modeling waxes are covered by ADA Specification No. 24[1], adopted by ISO[51]. Rather old American Federal Specifications outline similar flow requirements for casting, boxing, utility and sticky waxes [19].

In the past, only the basic rheological property of waxes, flow, was determined using different methods. Flow limits are defined in terms of the percentage change in length of a cylindrical specimen. According to ADA [1,2] , flow is measured by the arbitrary compressive loading of a cylindrical specimen of arbitrary size for an arbitrary period (10 min) at various temperatures, after which, flow is expressed as percentage of the initial length. Because of the fixed method and the arbitrary measuring conditions, we can only get a “critical flow property” of waxes [22]. In the period of loading, the geometry of specimens changes continuously, and consequently, the stress decreases continuously, and the strain rate cannot achieve equilibrium. As a result of the

percentage change in length is a meaningless value. The curves of flow are of continuously variable shape[21, 22]. And the measurements can be carried out only in a very narrow temperature range in practice. Discrimination becomes very poor or impossible at relatively high and low temperatures. Its use in a quantitative sense is invalid when the final shape of the specimens varies. So, the only adopted method of characterizing waxes in this respect is arbitrary and uninterpretable. We can also say that such a test is unsound [73].

Another proposed method is the Needle Penetration Test [49, 50]. A 'needle' or a 'probe' of specified dimensions and mass was to be held vertically against the surface of the wax specimen and released. After '(5±0.1)s' the needle was to be stopped, the vertical travel defining the penetrative 'flow'. Unfortunately, this method is similarly flawed by arbitrariness. In addition, the level of accuracy that could be attained is questionable. It can provide only a guideline indication of rheological properties. A specification based on a scientifically sound method is long overdue, despite the recognition of importance of flow in wax applications [22]. This method can also be recognized as a measurement used to determine the hardness of a wax. A softer wax will tend to bend or deform more readily, whereas a harder wax will be stronger and less chance for pattern deformation. Harder waxes are more dimensionally consistent than softer waxes.

In 1989, Darvell B.W. and Wong N.B.[27] showed a method to obtain the fundamental material property of viscosity by a modification of the Stokes' Law. The basic principle is that at equilibrium an object falling under gravity has a terminal velocity determined by the viscous drag on the body. With the help of a "push" to the ball, it was possible to get detailed data on wax viscosity as a function of temperature and load. They concluded that the shear thinning exponent, the reciprocal of the pseudoplasticity parameter, provides a similarly convenient measure of the stress-sensitivity of the wax. The problem is that the load is extra and variable and difficult to be controlled exactly. To avoid it, a non-contact means of monitoring the position of the load column was adopted by McMillan L.C. and Darvell B.W. in 2000 [73]. They concluded that the

viscosity of non-Newtonian time Independent waxes is dependent on temperature and shear rate. The viscoelastical properties of dental waxes are shear-thinning(aka. Pseudoplastic) [73]. This method can only measure the “apparent” viscosity and consistent specimen annealing, which is only an approximation to the waxes’ property of viscosity. Meanwhile, the mechanical control to the load and recording of velocity also make deviation to the results. It can also not be able to wholly investigate the complex rheological viscoelastitc properties of waxes.

The other methods used to determine the viscosity of a wax include: U-Tube, Brookfield, vibrating sphere, and stress/strain Rheometer. The U-Tube uses a kinematic technique to calculate the viscosity of the material, whereas the Brookfield, vibrating sphere, and Rheometer use a dynamic technique. The U-Tube is used for unfilled waxes and measures the flow of a specific amount of liquid wax over a certain interval. But it can only be applied to measure viscosities at particular temperatures per the manufacturer of the wax. The Brookfield viscometer is used for filled waxes and measures the viscous drag of the spindle. The vibrating sphere viscometer utilizes an oscillating sphere that maintains a certain amplitude, which is correlated to viscosity. It can be used for unfilled and filled waxes [74].

The three-point bend measurement was also used to determine the mechanical properties of casting wax [36]. Using small wax bars, this measurement can display a stress-strain curve and calculate several mechanical parameters, such as maximum load, load at break, strain at break, work done, modulus of elasticity and three-point modulus. Although these results allow us to explain a wax’s mechanical characteristics simply, they still can not elucidate its properties completely. Theoretically, the results of the applied load to a sample include three parts: compression; tension and shear. So, the test gives us information about the performance of the material under those particular conditions of loading, but not very much about any other circumstances. The deformation behaviour of the tested sample certainly reflects contributions from

all three aspects of the loading. In the three-point bend beam case it is likely to be due to the tension on the lower, convex surface [28]. This method cannot be used to calculate tensile strength since the sample is under compression and tension simultaneously [36]. Furthermore, the preparation of the wax bar is also complicated and arbitrary. It is sometimes difficult to manufacture reproducible samples, especially with more viscous blends. Because of the limitation of the specimen's type, it is impossible to characterize waxes at higher temperature or near the melting range. Certainly, it also cannot measure the variation of properties of waxes in a continuous cooling or heating condition directly.

Waxes exhibit peculiar rheological properties demanding novel techniques of study as conventional methods fail. With the development of rheometer, the investigation of mechanical properties of materials can be exactly performed under different shear or stress conditions. It is ideally suited to examine liquid/liquid, and liquid/solid transformations. Both in solid and in liquid, rheological measurement can be performed in a very wide temperature range. We can still study the temperature influence on the mechanical properties of samples with temperature sweep tests in a cooling or heating profile. Because of the very strongly temperature dependency of dental waxes, it is very helpful to analyze the rheological characteristics of waxes. The shear mode is applied to the sample, rather than tension, compression, bending or torsion. The investigation can be successfully performed with a small wax sample. With the control of computer and appropriate software, the experimental parameters (e.g. details of time, temperature, frequency, shear or stress profile, displacement amplitude, etc.) can automatically be calculated and presetted, depending on the nature of the particular requirement. With the analysis of mechanical parameters, such as dynamic viscosity ( $\eta'$ ), dynamic rigidity ( $G'$ ), loss modulus ( $G''$ ), the rheological properties of materials can be expressed completely.



Rheology measurements provide simple and effective means to compare the structural properties of waxes. They can be used in process control in the wax industry. Rheology has a wide range of applications to solve industrial problems especially in the controlling of the effects of temperature, ingredients, and processing parameters on formulations. In short, rheological testing has the capabilities of providing a wholly understanding of the characteristics of waxes. It is probably the most versatile and useful tool available for materials evaluation.

## 2.2 Rheology

### 2.2.1 Introduction

Rheology is the study of the deformation and flow of matter [38]. This definition was accepted when the American Society of Rheology was founded in 1929 [6]. Rheology describes the interrelation between force, deformation and time. The term comes from Greek “rheos” meaning to flow. From a broad perspective, rheology includes almost every aspect and behaviour that deals with the deformation of materials as a result of an applied stress. In other words, it is the study of the internal response of materials to external forces [66].

Rheology can be applied to all materials, from gases to solids, regardless of their kind, their physical state, or the form in which they are used [7, 106]. Fundamental to rheology are the concepts of material elasticity and viscosity. Materials will respond to an applied force by exhibiting either elastic or viscous behaviour or a combination of both mechanisms. Solids store mechanical energy and are elastic, whereas fluids dissipate energy and are viscous. The combined behaviour is termed viscoelasticity. Common to liquids, solids and substances in between the former two are that if a stress is applied to them, they will strain. If solids are elastic, they deform and return to their original shape. Since fluids are not elastic and, hence, viscous, their deformation is irreversible [6, 93].

Depending on the relations between deformation, stress and time scale, all materials, from gases to solids, can be divided into the following three categories of rheological behaviour [6, 38, 41, 43, 66, 93]:

- Viscous materials: in a purely viscous material all energy added is dissipated into heat (like water)

- Elastic materials: in a purely elastic material all energy added is stored in the material (like a steel spring)
- Viscoelastic materials: a viscoelastic material exhibits viscous as well as elastic behaviour. Typical examples of viscoelastic materials are bread dough, gluten, polymer melts and artificial or natural gels.

The rheological properties of ideally elastic and viscous materials can be described by a single value. The deformability of an elastic material can be defined by Hooke's constant (a modulus of elasticity). An ideally viscous material has a constant viscosity regardless of shear rate; the material shows so-called Newtonian behaviour and can be defined by a constant viscosity [67, 93]. Many materials, no less in dentistry, show more complicated behavior than that of purely viscous and elastic materials. The word 'viscoelastic' means the simultaneous existence of viscous and elastic properties in a material. It is not unreasonable to assume that all real materials are viscoelastic, i.e. in all materials, both viscous and elastic properties coexist. Viscoelastic properties are derived from testing of materials without destroying the structure (i.e., the structure is flexed and material is measured in its "ground state"). The viscosity often decreases as the shear rate is increased, which means deformation and stress depend on the time scale (shear rate). As a consequence, the system has to be defined by an apparent viscosity at each shear rate [46]. These materials are called shear-thinning materials. Viscoelastic materials are even more complicated in their behaviour and show a combination of viscous and elastic behaviour. The measurements are done through rheological flow and dynamic mechanical tests. The former investigates the flow viscosity, whereas the latter evaluates small periodic deformations that determine breakdown or rearrangement of structure or hysteresis [6, 41, 66]. There is a continuous interest in experimental measurement of the rheological properties of viscoelastic materials.

## 2.2.2 Theory of rheological measurements

### 2.2.2.1 Introduction

Rheology is used to describe the properties of a wide variety of materials [13, 66]. Dental materials, such as dental waxes and impression materials *et. al*, can also be elucidated rheologically to insure the practical applications. Rheological measurements are normally performed in kinematic instruments in order to get quantitative results useful for design and development of products and process equipment. Dynamic measurements require an instrument that can generate sinusoidal strain as an input to the fluid under test and record the stress resulting from the fluid deformed as an output. An instrument only capable of measuring shearing viscosities is called a viscometer and the oscillating type is called a rheometer [93].

Rheometer is used in the industry at various levels of sophistication to provide information for different purposes, as quality control, product development, process engineering and consumer studies. The measurements obtain correlations between molecular structure and material properties, and between material properties and behaviour in practical situations. They may also be used to predict material behaviour in complex flow situations [7, 67, 93]. This requires sophisticated mathematical treatments using data obtained from simple rheological experiments. Without rheology, nothing in materials and process engineering can function today.

A rheometric measurement normally consists of a strain (deformation) or a stress analysis at a constant frequency (normally 1Hz) combined with a temperature or frequency analysis. The strain and stress sweep tests give information of the elastic modulus  $G'$ , the viscous modulus  $G''$  and the phase angle  $\delta$ . A large value of  $G'$  in comparison of  $G''$  indicates pronounced elastic (gel) properties of the product being analysed. For such a product the phase angle is also small, e.g.  $20^\circ$ . The temperature sweep gives information of the

mechanical properties in dependence on temperature. The frequency sweep gives information about the gel strength where a large slope of the  $G'$  curve indicates low strength and a small slope indicates high strength [6, 93, 101]. For design of products, e.g. in the medical, food, cosmetic or paint industry, rheometric measurements are often performed to establish the elastic properties, such as gel strength and yield value, both important parameters affecting e.g. particle carrying ability and spread ability. Rheological findings are of fundamental importance for the development, manufacture and processing of innumerable products. Presently, with the help of modern digital rheometer, we can easily carry out the rheological measurements to analyse the rheological characteristics of matters.

## **2.2.2.2 Viscoelastic properties**

### **2.2.2.2.1 Introduction**

Viscoelastic materials have simultaneously elastic and viscous properties. The term 'viscoelasticity' (VE) is used to describe behaviour which falls between the classical extremes of elastic response by the Hookean solids and the Newtonian liquids. Hooke's and Newton's laws are linear laws, which assume direct proportionality between the stress and the strain, or the rate of strain, whatever the stress [6]. The viscous portion behaves according to Newton's law, and the elastic portion behaves according to Hooke's law. It is not unreasonable to assume that all real materials are viscoelastic [38, 78]. Some energy may always be stored during the deformation of a material, and there is always some unrecoverable deformation during long-term stress [95]. Which property dominates, and what the values of the parameters are, depends on the stress and the duration of stress application [6, 7].

Depending on their rheological behavior, viscoelastic liquids differ from viscoelastic solids. Viscoelastic materials always display a delayed response when load is applied and removed. For many years, many scientists have been expended in the determination of the linear viscoelastic response of materials. There are many reasons for this [10, 101]. First, there is the possibility of

elucidating the molecular structure of materials from their linear viscoelastic response. Secondly, the material parameters and functions measured in the relevant experiments sometimes prove to be useful in the quality-control of industrial products. Thirdly, a background in linear viscoelasticity is helpful before proceeding to the much more difficult subject of non-linear viscoelasticity.

#### 2.2.2.2 Mechanical modelling of linear viscoelastic properties

When the mechanical properties of the material are experimentally determined, the linear viscoelastic behavior can be analyzed by using a proper mechanical model. These mechanical models consist of springs and dashpots arranged in parallel and/or in series. In these mechanical models, the Newtonian flow is represented by a dashpot, an element in which the force is proportional to the rate of extension (Figure 2(a)), and the Hookean deformation is represented by a spring, an element in which the force is proportional to the extension (Figure 2(b)). A spring with recovering properties stores energy; a dashpot with non-recovering properties dissipates energy [68].

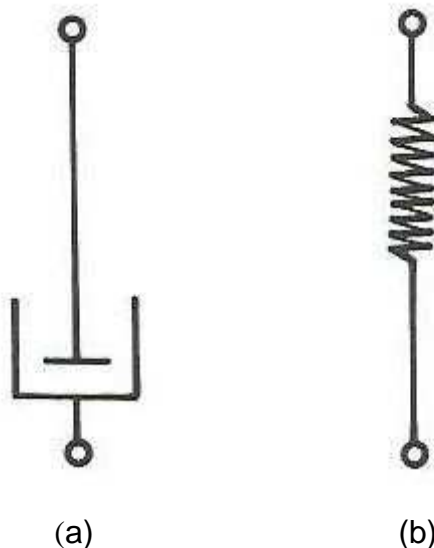

Figure 2 Mechanical representation of a viscoelastic materials using a dashpot (a) and a spring (b) [68]

The generalized Maxwell model is frequently used to describe the linear viscoelastic response of the liquid. It can be represented as a parallel series of Maxwell elements (Figure 3), consisting of linear springs and dashpots. Both components can be deflected independently of each other [9, 91, 93, 94].

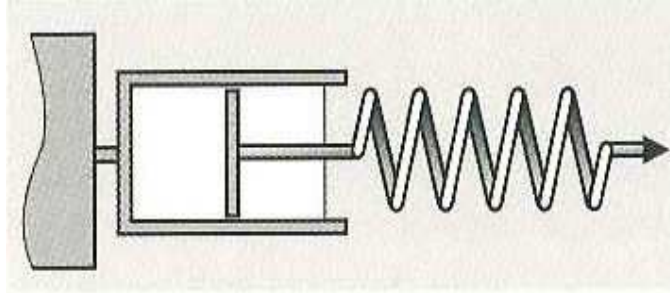

Figure 3 The Maxwell model: The dashpot and spring are in series as a Mechanical model of viscoelastic material [93]

In Maxwell model, the shear stresses in both the elements are always identical and the deformations are additive [93]. Before the load, both components are undeformed. When a load is applied, this model reaction firstly shows the elastic response of the spring. Later, the fluid shows a viscous response in a dashpot, i.e. the deformation is unlimited as long as the load is applied. After the removal of the load, the drop in strain is related to the release of load in the spring, while the remaining permanent strain is equivalent to the amount of viscous flow in the dashpot. After a load cycle, the sample remains partly deformed. The material behaves essentially as a liquid and is referred to as a viscoelastic or Maxwell liquid [66, 67, 93].

The behavior of a viscoelastic solid can be illustrated using the combination of a spring and a dashpot in parallel connection, the Kelvin/Voigt model (Figure 4). Both components are connected through a rigid frame [9, 91, 93, 94].

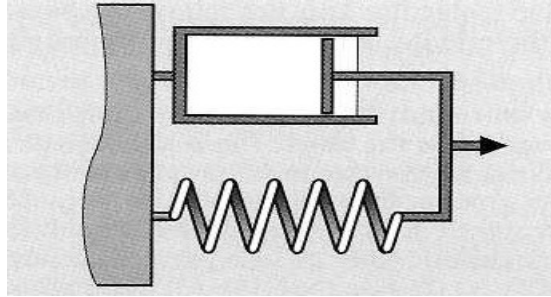

Figure 4 The Kelvin/Voigt model. The dashpot and spring are combined in Parallel as a mechanical model of viscoelastic material [93]

A spring and a dashpot in parallel represent a material whose response to an applied load is not instantaneous but is related to a viscous resistance [7, 93, 94]. Before the load phase, both components are undeformed. After a sudden load, the both components can only be deformed together, which was simultaneously and to the same extent. The deformation increases as long as the constant load is applied [93]. The spring will eventually reach the strain, but the dashpot will retard the growth of the strain [6]. A removal of the load allows the material to fully recover. But the recovery of the strain is retarded, because of the presence of dashpot. After a load cycle, the sample shows delayed but complete reformation which fully compensates for the previous deformation. The material behaves essentially as a solid and is referred to as a viscoelastic solid [7, 93, 94].

The mechanical models, maxwell and Kelvin/Voigt, representing viscoelastic behavior in two different ways, may be combined into generalized model to incorporate all possibilities of flow and deformation of Non–Newtonian materials [68]. The rheological behavior of many viscoelastic materials is often too complex to be successfully depicted by using a single mechanical model. One or several Kelvin/Voigt units may be combined with Maxwell elements. The more complicated the structure of the material, the more elements are needed to formulate a mechanical model. By connecting enough single elements of Maxwell and Kelvin/Voigt, even very complicated viscoelastic structures can be represented [6, 7, 66, 67, 68, 93].



### 2.2.2.2.3 Mathematical modeling of linear viscoelastic properties

The quantitative interpretation of the rheological data, obtained with experimental tests, requires description of the rheological response by using mathematical model, providing different parameters with various physical meanings [35, 37]. The development of the mathematical theory of linear viscoelasticity is based on a “superposition principle”. This implies that the response (e.g. strain) at any time is directly proportional to the value of the initiating signal (e.g. stress) [6]. The rheological models, based on the phenomenological approach, have been developed to achieve maximum agreement between the predicted and experimental rheological properties of matters, by taking into account only the principles of continuum mechanics, regardless of structural characteristics[59, 60]. In the linear theory of viscoelasticity, the differential equations are linear, the ratio of stress to strain is a function of time alone [55].

The rheological behavior of materials can be determined under steady-shear and oscillatory shear [66]. In steady-shear experiments, the viscosity of the sample is measured as a function of shear stress or shear rate. However, steady-shear measurements are not very sensitive to the microstructure present in the system. Dynamic rheology, performed under oscillatory shear, is the preferred technique for detecting microstructural features [35, 66]. A number of small-deformation experiments are used to measure the linear viscoelastic response of the material [6, 66]. When the low-amplitude oscillatory shear technique is used, the sample is subjected to a sinusoidal shear strain,  $\gamma$ , and the resulting oscillatory shear stress,  $\tau$ , is measured. As a response of the material to the oscillating strain input, the shear stress will also oscillate sinusoidally at the same oscillation frequency,  $\omega$ , but in general it will be shifted by the phase angle,  $\delta$ , (Figure 5),

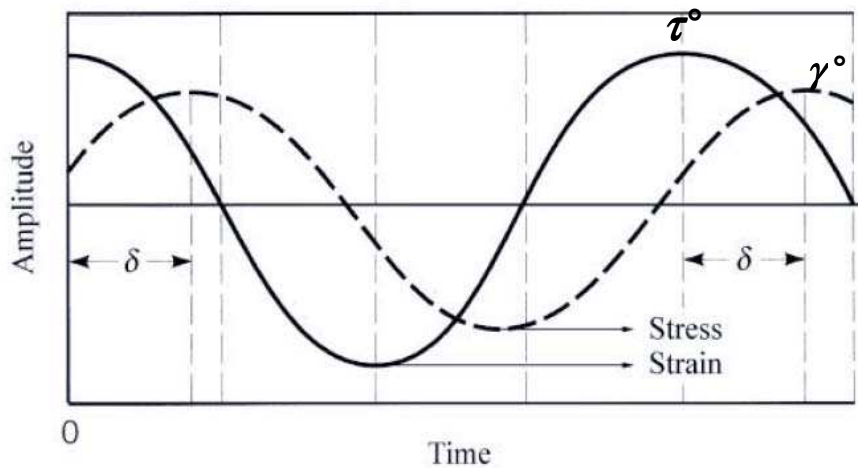

Figure 5 An oscillation strain and the stress response for a viscoelastic material. The shear stress  $\tau(t)$  resulting from successive jumps in the strain  $\gamma(t)$ .  $\delta$  is the phase angle defining the lag of the stress behind the strain [87]

which is the measured phase lag between the applied stimulus and the response, with respect to the strain wave as described with the following mathematical expressions [66] :

$$\gamma = \gamma^\circ \sin \omega t$$

$$\tau = \tau^\circ \sin (\omega t + \delta)$$

where  $\gamma^\circ$  is the shear strain amplitude, and  $\tau^\circ$  is the shear stress amplitude. Within the region of linear viscoelasticity, the resulting stress is also sinusoidal and can be decomposed into an in-phase and an out-of-phase component [35]. At phase angle  $0^\circ$ , the in-phase response, shows that the sample is ideal elastic material, and at phase angle  $90^\circ$ , the out-of-phase response, shows that the sample is ideal viscous material [67]. With viscoelastic materials the phase angle,  $\delta$ , between the applied stress/strain and the resulting strain/stress is between  $0^\circ$  and  $90^\circ$ . The phase angle is a good indicator of the overall viscoelastic nature of the material [38].

When the amplitude ratio and the phase angle are measured, the parameters representing viscoelastic behaviour can be calculated. Two dynamic moduli, the storage modulus,  $G'$ , and the loss modulus,  $G''$ , are introduced:

$$\tau = \gamma^\circ G' \sin \omega t + \gamma^\circ G'' \cos \omega t$$

The stress component in-phase with the deformation defines the elastic (or storage) modulus  $G'$  and is related to the elastic energy stored in the system on deformation.

$$G' = (\tau/\gamma) \cos \delta$$

The greater the  $G'$ , the more elastic are the characteristics of the material.

The component out-of-phase with the strain gives the viscous (or loss) modulus  $G''$ , which is linked to the viscous dissipation of energy in the system.

$$G'' = (\tau/\gamma) \sin \delta$$

The greater the  $G''$ , the more viscous are the characteristics of the material.

The storage modulus represents the spring-like deformation in mechanical models, while the loss modulus represents the dashpot-like deformation [6].

The storage modulus,  $G'$ , and the loss modulus,  $G''$ , are the real and the imaginary component of the complex modulus,  $G^*$ , respectively:

$$G^* = \frac{\tau^\circ}{\gamma^\circ} = G' + iG'' = \sqrt{G'^2 + G''^2}$$

and the ratio between the dynamic moduli can be written as follows:

$$G''/G' = \tan \delta$$

which is proportional to the ratio of energy dissipated/energy stored. This is called the loss factor or damping factor,  $\tan \delta$ . It is also an indicator of the ratio of viscous to elastic behavior of materials, showing which one is the dominant one. With a  $\tan \delta$  value of 1, the elastic and viscous properties of the material

are equal. A lower loss factor implies a more elastic gel structure. Loss factor,  $\tan \delta$ , is often the most sensitive indicator of various molecular motions within the material [3, 38, 65].

## 2.2.3 Oscillatory tests

### 2.2.3.1 Principles

Oscillatory tests can be used to examine all kinds of viscoelastical materials [94]. The basic principles of oscillatory tests can be explained using a “Two-Plate-Model” (Figure 6). The oscillations of the upper plate are produced by a turning wheel on which a push rod is connected eccentrically. The other end of the rod is attached to the upper plate.

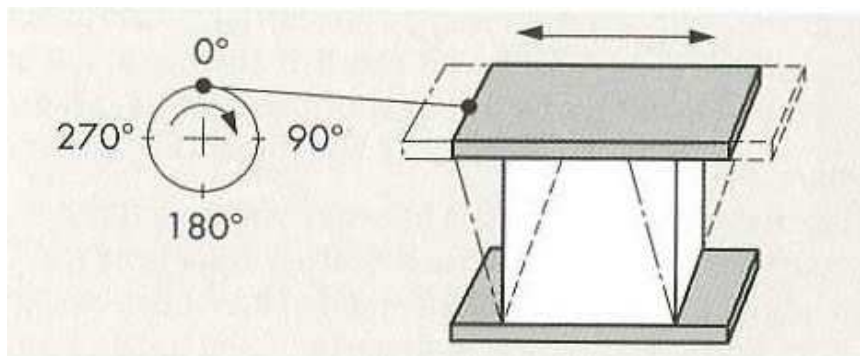

Figure 6 The Two-Plate-Model for Oscillatory tests [93]

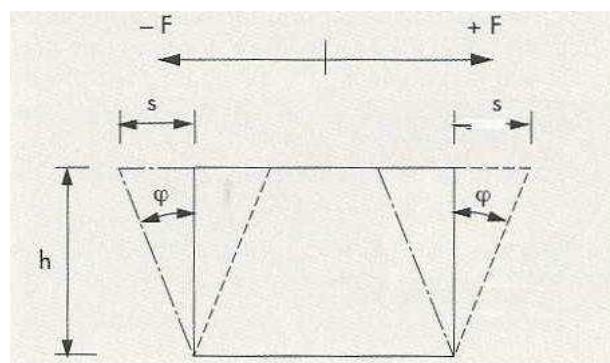

Figure 7 Shear force  $\pm F$ , deflection  $\pm s$  and deflection angle  $\pm \phi$  of the sample in the shear gap  $h$  during an oscillatory test [93]

When the driving wheel turns, the upper plate with the (shear) area  $A$  is moved back and forth by the shear force  $F$  (Figure 7), causing to oscillate sinusoidally at a set frequency  $\omega$  ( $\text{rad s}^{-1}$ ) and angular amplitude. The lower plate is immovable. So, the shearing of the sample between the two plates was caused. The following two conditions are necessary. Firstly, the sample must be adhere to both plates and not slid or slip along them. Secondly, the sample must be deformed homogeneously throughout the whole shear gap (which corresponds to the distance  $h$  between the two plates).

The shear stress which occurs is  $\pm\tau$  [ Pa ] =  $\pm F/ A$  and the deformation is  $\pm \gamma = \pm \tan \varphi$ .

For idealelastic materials, Hook's law is applied:

$$\tau(t) = G^* \cdot \gamma(t)$$

In oscillatory tests, the complex shear modulus,  $G^*$  represents the rigidity of the sample, i.e. the resistance to deformation. For samples showing idealelasticity, there is no phase shift between the two curves,  $\delta = 0$ .

For idealviscous materials, Newton's law is applied:

$$\tau(t) = \eta^* \cdot \dot{\gamma}(t)$$

In oscillatory tests, the complex viscosity,  $\eta^*$  represents the flow resistance of the sample. For samples showing idealviscous, there is a delay between the two curves,  $\delta = 90^\circ$ .

For viscoelastic materials, the oscillatory tests can be performed both in control strain and control stress conditions.

a) For tests with control shear strain as the sine function:

$$\gamma(t) = \gamma_A \cdot \sin \omega t, \text{ with the shear strain amplitude } \gamma_A \text{ [ \% ]}$$

b) For tests with control shear stress as the sine function:

$$\tau(t) = \tau_A \cdot \sin \omega t, \text{ with the shear stress amplitude } \tau_A \text{ [ Pa ]}$$

The corresponding measuring results are as follows:

a) With control strain:  $\tau$  curve as the phase shifted sine function

$$\tau(t) = \tau_A \cdot \sin(\omega t + \delta)$$

b) with control stress:  $\gamma$  curve as the phase shifted sine function

$$\gamma(t) = \gamma_A \cdot \sin(\omega t + \delta)$$

The sine curve of the measured response is shifted by the angle  $\delta$  compared to the presetted sine curve. For viscoelastical materials, this angle is between  $0^\circ$  and  $90^\circ$  ( $0^\circ < \delta < 90^\circ$ ).

### 2.2.3.2 Amplitude sweep

An amplitude sweep is an oscillatory test with variable amplitude and constant frequency value. It is mostly carried out for the sole purpose of determining the limit of the LVE-range of viscoelastic materials. The amplitude sweep test can be performed with controlled shear strain (deformation, a variable strain amplitude,  $\gamma_A$ ) (CSD) or with controlled shear stress (a variable shear stress amplitude,  $\tau_A$ ) (CSS). For the data analysis, it does not matter whether the strain is prescribed and the stress is responding, or vice versa.

The sample is often tested at an angular frequency of  $\omega = 10$  1/s. The diagram of the measuring results is plotted between  $\lg G'$ ,  $\lg G''$  (y-axis) and  $\lg \gamma$  (or  $\lg \tau$ ) (x-axis). Sometimes  $\tan \delta$  is also displayed on the y-axis (Figure 8).

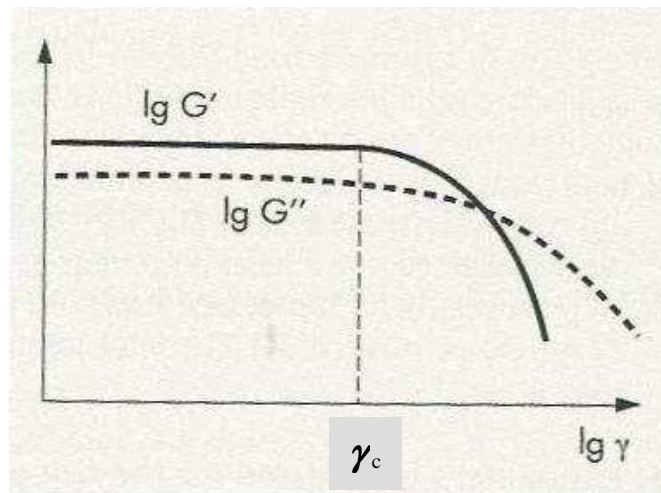

Figure 8 Schematic drawings of amplitude sweep test:  $G'(\gamma)$  and  $G''(\gamma)$  with the critical value  $\gamma_c$  of the LVE strain range [93]

In the linear viscoelastic (LVE) range at low amplitudes, each of the functions  $G'(\gamma)$  and  $G''(\gamma)$  shows a constant plateau value. The following relations concerning the structure of the materials can be found in the LVE-range. They are very helpful for the quality control.

- a. Gel character,  $G' > G''$ : The elastic behavior dominates over the viscous behavior. The structure shows a certain rigidity. The sample is form stability.
- b. Liquid character,  $G'' > G'$ : In this case, the viscous behavior dominates over the elastic behavior. The sample shows the character of a liquid in the LVE-range.

The deformation behavior outside the LVE-range is referred to as non-linear. The mechanical modulus,  $G'$  and  $G''$ , will decline, but at different velocity. At the stress of crossing over point, the loss modulus,  $G''$ , is equal in value to the storage modulus,  $G'$ , and the loss tangent is 1 [35, 39]. An increasing in stress of crossing over point is a sign of more lasting elastic properties. The crossing over point gave the same results as the storage modulus; the greater the elasticity of waxes, the more lasting was the elasticity under increasing stress [6, 35].

### 2.2.3.3 Temperature ramp oscillation test

In this type of oscillatory test, both the frequency and the amplitude are kept constant. This means that the constant dynamic mechanical conditions are given. Temperature is often set as a temperature/time profile  $T(t)$ . Usually we use the profile of linear heating (or cooling) rate in the form of ramps upwards (or downwards).

Like amplitude sweep test, there are also two types presettings of this test: controlled shear strain and controlled shear stress. The measuring result can also be showed as a diagram, in which the temperature  $T$  is displayed on the x-axis on a linear scale, whilst on the y-axis  $\lg G'$  and  $\lg G''$  are usually both plotted on the same logarithmic scale. Sometimes,  $\tan \delta (T)$  can also be presented in the diagram. Figure 9 shows the schematic curves of  $G'(T)$ ,  $G''(T)$  and  $\tan \delta (T)$  in a cooling process.



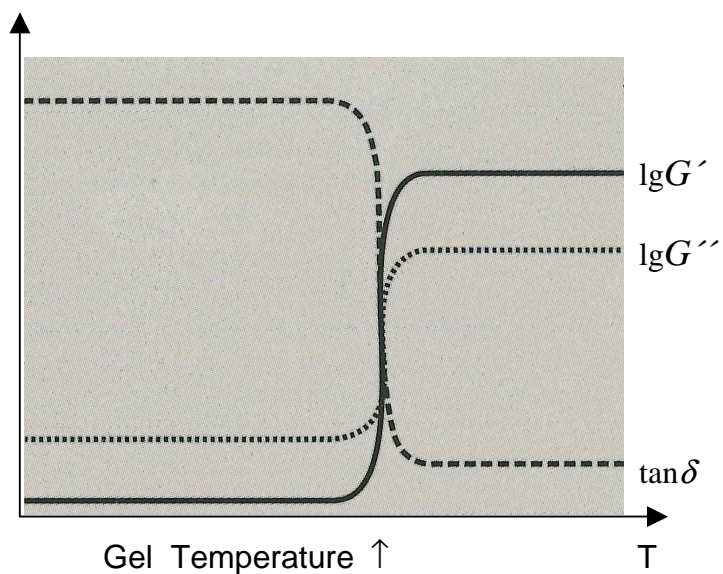

Figure 9 Schematic diagram of temperature ramp oscillation test  $\lg G'(T)$ ,  $\lg G''(T)$  and  $\tan \delta(T)$  during cooling process

Oscillatory tests allow measurements without destroying the sample even when it has changed to the solid state. The  $\lg G'(T)$  and  $\lg G''(T)$  or  $\tan \delta(T)$  can reveal the informations on the structural character. The temperature at which  $G'$  and  $G''$  curves intersect is called the sol/gel transition temperature or gel temperature for short. At this temperature,  $G' = G''$  or  $\tan \delta = 1$ .

### **2.3 Aims of the rheological research of dental waxes**

This investigation is concerned with the influences of temperature on the rheological characteristics of dental waxes. The aims of this inquiry are:

- i) To apply the novel rheological investigation to analyse the properties of dental waxes;
- ii) To provide rheological data of dental waxes on the effect of temperature;
- iii) To provide suggestions for further researches.

### **3 Materials and Methods**

#### **3.1 Materials**

Seven different dental waxes were selected to study the rheological characteristics, namely No.011-2, No.011-3, No.015, No.016, No.016-1, No.017, and No.018. All these waxes were provided by Dentaurum GmbH (Ispringen, Germany). Except for No. 018, the control wax, all others were new experimental waxes. They are shown in Table 1.

**Table 1 The Experimental Waxes**

Waxes	SP/DP/P *	No.011-2	No.011-3	No.015	No.016	No.016-1	No.017	No.018
Middle Microcrystalline waxes(hard)(%)	84/88/1-2	50	50	50	41.67	40	38.46	
Middle hydrocarbons resins(%)	109	5	5	5	8.33	8	7.69	
Middle hydrocarbons resin(%)	100-110	5	5	5	8.33	8	7.69	
Hard natural stable fatty acid(%)	100-110	40	40	40	33.33	32	33.33	
Hydrocarbon wax with microcrystalline structure(%)	77/89/20-26	10	–	20	8.33	12	15.38	
Sum(%)		110	100	120	100	100	100	

1) \* SP - Solidification point in°C; DP - Drip point in °C; P - Penetration 1/ 10mm.

2) There are 0,03% pigment in all prescriptions.

3) No. 018 was designed as control.

### 3.2 Preparation of wax samples

All samples were firstly cutted into small pieces and loaded into the lower measuring plate in order to be heated to the experimental temperature. An insulation cover was used in the period of heating to keep the stability of wax temperature (Figure 10(a)). The measured waxes were kept at the experimental temperature about 10 minutes to avoid air bubble incorporation since the presence of air bubbles in the sample can interfere with the test results. Then the upper measuring plate of the geometry was lowered to the measuring position (measuring gap 0.35mm). The excessive sample was slightly trimmed off, because these waxes will also influence the measuring results. To get the temperature equivalence for the upper plate, an equilibration time of 10 minutes was presetted through the option of "With waiting time" before starting each test. Another insulation cap with a hole in the center was applied to minimize temperature loss during the measurement (Figure 10(b)).

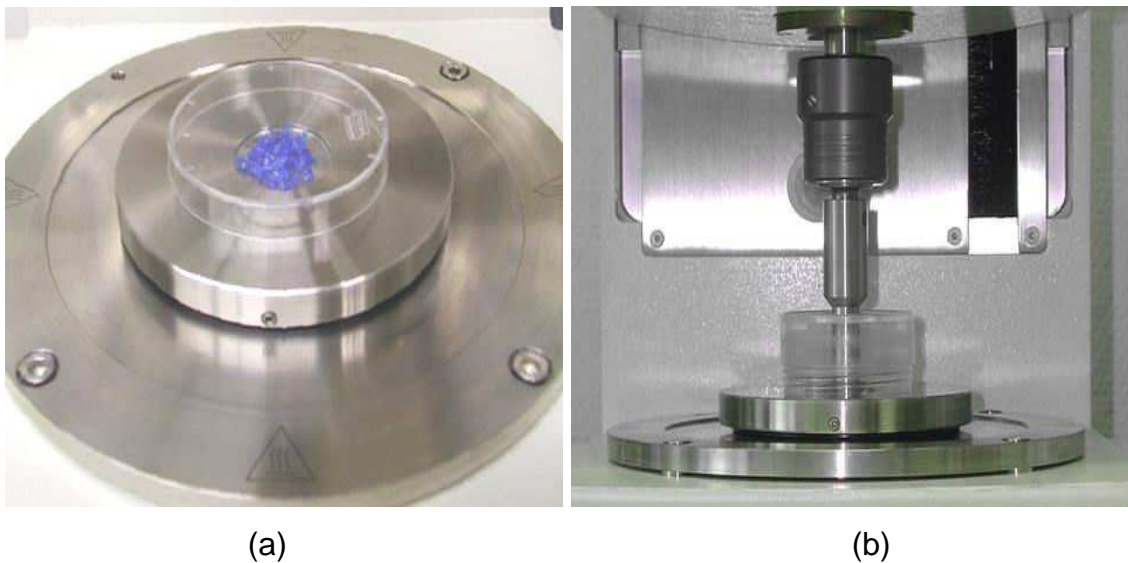

Figure 10 Application of insulation covers in the heating(a) and measuring procedures(b)

### 3.3 Rheometer

Rheological measurements were carried out by a Paar Physica UDS200 Rheometer, manufactured by PHYSICA Messtechnik GmbH, Stuttgart, Germany (see Figure 11). The machine apparatus is with an air bearing and an electronically commutated (EC) synchronous with DSP technology for digitally controlled CSS and very rapid CSR / CSD tests [63]. It was designed to be used in research and development as well as quality control. The instrument was updated and linked to a PC. The computer runs the newest Paar Physica US200 Software, version 2.43, which is built around a universal concept in regard to flexibility and instrument compatibility, a package that gives full control of the instrument and allows the capture, manipulation and storage of rheological data [98]. The needed rheological analysis methods are also included in the software. Problems were solved to actually put the machine to run properly.



Figure 11 Paar Physica Rheometer UDS200 and Thermostat unit (Julabo)

All the rheological measurements were carried out using parallel plate geometry MP30 with a gap height of 0,35mm (Figure 12). The diameter of the measuring plate is 25mm. This kind geometry consists of two plates. The surfaces of both the plates are flat. The measuring sample is sandwiched between two disk-shaped coaxial, perfectly circular plates of which one rotates.

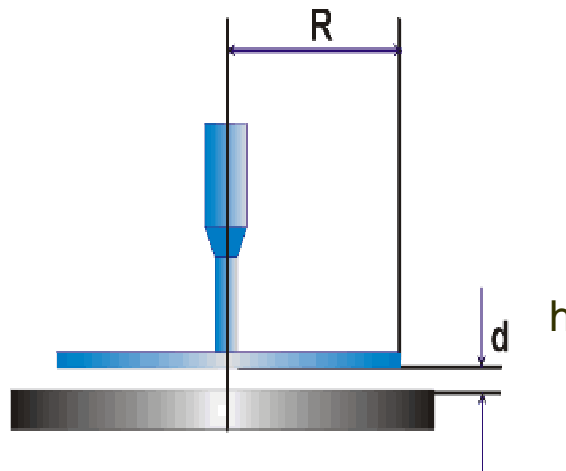

Figure 12 Schematic diagram of Parallel Plate Measuring System [104]

Traditionally, the whole lower immobile plate of the parallel plate measuring system is also flat [29, 30, 47, 48]. But it is not convenient to control the measuring samples in the period of measurement. To make a better controlling of wax samples, an improved stainless steel plate was applied as the lower part of MP30, which is fastened by three screws to the original motionless plate. In the centre of the new plate, a small round pan was milled. The radius and depth of the pan is 13mm and 1mm, respectively, which are corresponding to the geometry of the upper plate (Figure 13).

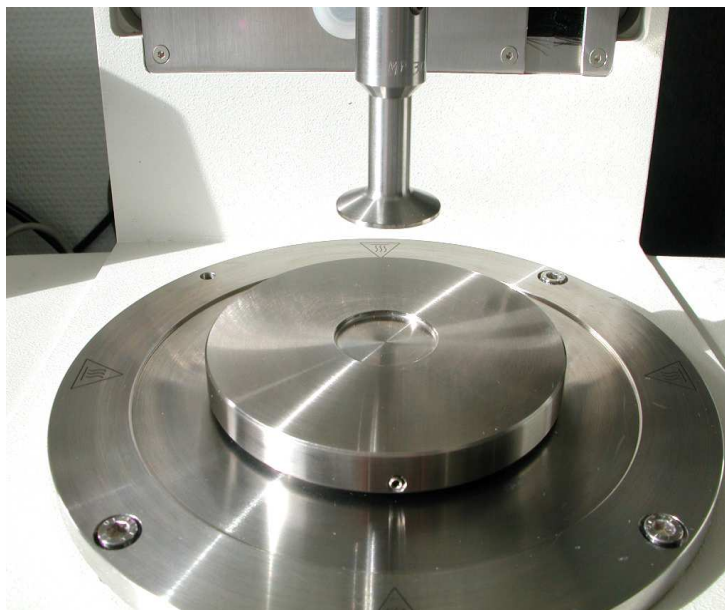

Figure 13 Improved Parallel Plate measuring geometry MP30: the upper plate and corresponding new lower plate

For precise control of the sample's temperature, a peltier system TEK130P and a circulating fluid bath (Julabo thermostat) were used as the environmental control system (Figure 11). The sample temperature is monitored and displayed by a PRT (Platinum Resistive Thermometer) thermocouple with an accuracy of  $\pm 0.01^\circ\text{C}$  [64, 104].

The apparatus calibration was necessary before tests started. Following the steps shown in the manual, this phase was easily completed. For instruments with oscillation mode, most important is to check the moment of inertia of the drive before starting to use the instrument. To do this switch on the instrument and wait about 20 min for it to warm up. Remove any measuring system and move the instrument head to measurement position. Select 'Drive' under 'Determine Inertia of Meas. System or Drive' from 'Configuration' in the device setup dialog. Using the standard values for the inertia determination, the drive inertia value can be automatically measured and stored [96, 97, 98, 99].

The operating procedures was listed in Appendix 7.2. The following measuring skills must be drawn attention:



- The amplitude sweep tests of all samples were performed firstly. The temperature ramp oscillation tests were carried out in LVE-range for each wax.
- For each test, the samples were firstly heated to 100°C (amplitude sweep) and 120°C (temperature ramp oscillation tests). It is benefit for the upper measuring shaft to achieve the exact measuring position. Then the measuring temperature was sent to the rheometer to control the peltier and thermostat system. Before the starting of the measurement, make sure that the samples between the two plates are enough and there are no air bubbles.
- Active the “Automatic Gap Control”(AGC) option in the temperature ramp oscillation tests to be sure the constant gap during the measurement.
- Each sample was left at rest for 10 minutes before the test was carried out in order to ensure the equilibrium structure and the same starting conditions for all waxes examined [83].

### 3.4 Rheological experiments

Dynamic strain and stress sweep tests, temperature ramp oscillation tests were conducted to determine the viscoelastic properties of dental waxes (see Table 2). All the tests were done at least in triplicate for each wax and all measurements were made from separate samples.

Table 2: Series of rheological measurements of dental waxes

Dental waxes	Amplitude sweep	Amplitude sweep	Temperature rampe
	(CSD)	(CSS)	oscillation test
	50 - 90°C with 10°C interval		120°C – 20°C
No.011-2	x	x	-
No.011-3	x	x	x
No. 015	x	x	x
No. 016	x	x	x
No.016-1	x	x	x
No. 017	x	x	x
No. 018	x	x	x

Note:

\* CSD: control shear strain; CSS: control shear stress

\*\* Because of the supplying of wax sample, wax No. 011-2 was not included in the temperature rampe oscillation test

The aims of the rheological measurements are as follows:

- (1) Amplitude Sweep Tests(CSD): mainly to determine the linear viscoelastic region of dental waxes;
- (2) Amplitude Sweep Tests(CSS): to determine a dynamic profile of dental waxes;
- (3) Temperature Ramp Oscillation Tests: to investigate the characteristics of dental waxes in dependence on temperature.

### 3.4.1 Amplitude Sweep Tests (CSD)

Amplitude sweep tests (CSD) were performed to ascertain the viscoelastic behaviour, a mutual measurement range, valid for all analyzed dental waxes. The test measures the strain amplitude dependence of the storage and loss moduli ( $G'$  and  $G''$ ) by applying a range of sinusoidal deformations (strains) at a fixed angular frequency. For most viscoelastic materials, the response of the system is linear until a critical strain,  $\gamma_c$ , at which point both  $G'(\gamma)$  and  $G''(\gamma)$  show a sudden decrease. This measurement can be used to determine the critical yield strain of the sample, which is the strain at which the sample begins to flow.

Amplitude strain sweep tests were conducted from 0.01% to 10 % strain at a constant angular frequency of  $10\text{S}^{-1}$  and in the temperature range from  $50^\circ\text{C}$  to  $90^\circ\text{C}$  with an interval of  $10^\circ\text{C}$ . The dynamic storage and loss modulus ( $G'$ ,  $G''$ ) and loss factor  $\tan\delta$  were plotted against shear strain (%),  $\gamma$ .

### 3.4.2 Amplitude Sweep Tests (CSS)

Based on an EC-motor, electronically commutated (EC) synchronous motor, the real controlled stress test can be done simultaneously with CSD using the same rheometer in the temperature range of  $50^\circ\text{C}$ - $90^\circ\text{C}$  at an interval of  $10^\circ\text{C}$ . The parameters  $G'$ ,  $G''$  and  $\tan\delta$  were determined at a constant angular frequency of  $10\text{S}^{-1}$  and plotted against shear stress,  $\tau$ , at different temperatures.

### 3.4.3 Temperature Ramp Oscillation Tests

Temperature ramp oscillation tests were carried out to analyse the temperature influence on the rheological behaviour of dental waxes. It was designed to have a better understanding of its viscoelastic property as well as its sol-gel transition process.

With a linear profile of stepwise ramp of temperature range from 120°C to 20°C, the temperature oscillation tests were then performed at a constant angular frequency ( $\omega$ ) of  $10\text{S}^{-1}$  during cooling to analyse the temperature behaviour of phase and structure transformations. The deformation was presetted as a constant value of 0.01%, which was in the linear viscoelastic range for all of the specimens. This could avoid any possible sample disruption during the gelation and make sure that all the parameters were measured from linear viscoelastic spectra. With 100 measuring points (1 minute acquisition time), temperature was decreased stepwise in 1°C/min increments. The temperature was controlled by Peltier system (TEK130P) and thermostat unit (Julabo F10). The viscoelastic parameters, mechanical modulus ( $G'$ ,  $G''$ ) and  $\tan\delta$ , were determined and plotted against temperature to monitor the gelation kinetics.

### **3.5 Statistical Analysis**

With the installed analyse methods in the software, all the needed parameters, such as storage modulus,  $G'$ , loss modulus,  $G''$ , loss factor,  $\tan\delta$ , gel temperature, etc. can be calculated. Results are given as means  $\pm$  standard deviations (SD) for  $n=3$ . Statistical analysis was made using the statistical software Microcal™ Origin® Version 6.0 for windows. T-test was performed to identify significant differences between new experimental waxes and control wax No.018 at the 95% confidence level.

## 4. Results and Discussions

The results of rheological experiments of dental waxes were split into the following sections. Firstly, the amplitude sweep tests would be performed to analyze the shear dependence properties of dental waxes at different temperatures. The strain sweep tests (CSD) were conducted to analyse the linear viscoelastic characteristics of the samples. Meanwhile, the understanding of the mechanical behaviors of the samples in dependence of the shear stress was also investigated by the amplitude sweep tests (CSS). The amplitude sweep tests were produced for each experimental wax at different temperatures both in CSD and CSS mode. Furthermore, temperature ramp oscillation tests were studied so that a more in depth evaluation of the viscoelastic properties and the behavior in dependence on temperature of the samples could be made. All data would be provided in the electronic version. The diagrams data would be in an .ORX-Datei files which could be analysed by the software US200 version 2.43. All the typical measured rheological curves were displayed in appendix. T-test was performed to determine the statistical significance of all the analyzed parameters between each new experimental wax and control wax No.018.

### 4.1 Shear dependent behaviors of dental waxes

The dynamic properties of dental waxes were performed by amplitude sweep tests, both in control shear strain, CSD, and control shear stress, CSS, mode. When the small-amplitude oscillatory shear technique was used, the sample was subjected to a sinusoidal shear strain,  $\gamma$ , and the resulting oscillatory shear stress,  $\tau$ , was measured. The material could be measured both in the oscillating strain and stress condition at the same oscillation frequency,  $\omega$ . Generally, shear stress would be shifted by the phase angle,  $\delta$ . The dynamic parameters would be plotted against shear strain (CSD), and stress (CSS), respectively.

Appendix 7.3 and 7.4 illustrated the summarized diagrams of amplitude sweep tests of all the experimental waxes at different measuring temperatures in CSD and CSS mode, respectively.

- Appendix 7.3 (Figure 14 to 25): The comparisons of the typical diagrams of amplitude sweep tests (CSD) of each wax at different temperatures and all waxes at each temperature were shown, respectively.
- Appendix 7.4 (Figure 26 to 37): The comparisons of the typical diagrams of amplitude sweep tests (CSS) of each wax at different temperatures and all waxes at each temperature were displayed, respectively.

Two important features of the rheological response were apparent from these plots. Firstly, the appearance of Newtonian plateau in the low shear conditions was observed for all tested waxes (Appendix 7.3 and 7.4). The moduli  $G'$  and  $G''$  were both independent of shear strain/stress. Another observation of the amplitude sweep tests was that at all tested temperatures, the storage modulus  $G'$  significantly exceeds the loss modulus  $G''$  in the LVE-range, both in strain and stress sweep tests, meanwhile the values of loss factor ( $\tan\delta$ ) were very smaller than one. These behaviors are typical for all the series of dental waxes under investigation. Figure 38 showed an example of the typical amplitude sweep tests (CSD and CSS) of waxes studied. The minimal loss tangent ( $\tan\delta$ ) values in the linear viscoelastic region of all experimental waxes at each tested temperature showed that the elastic properties were clearly more dominant than the viscous ones.

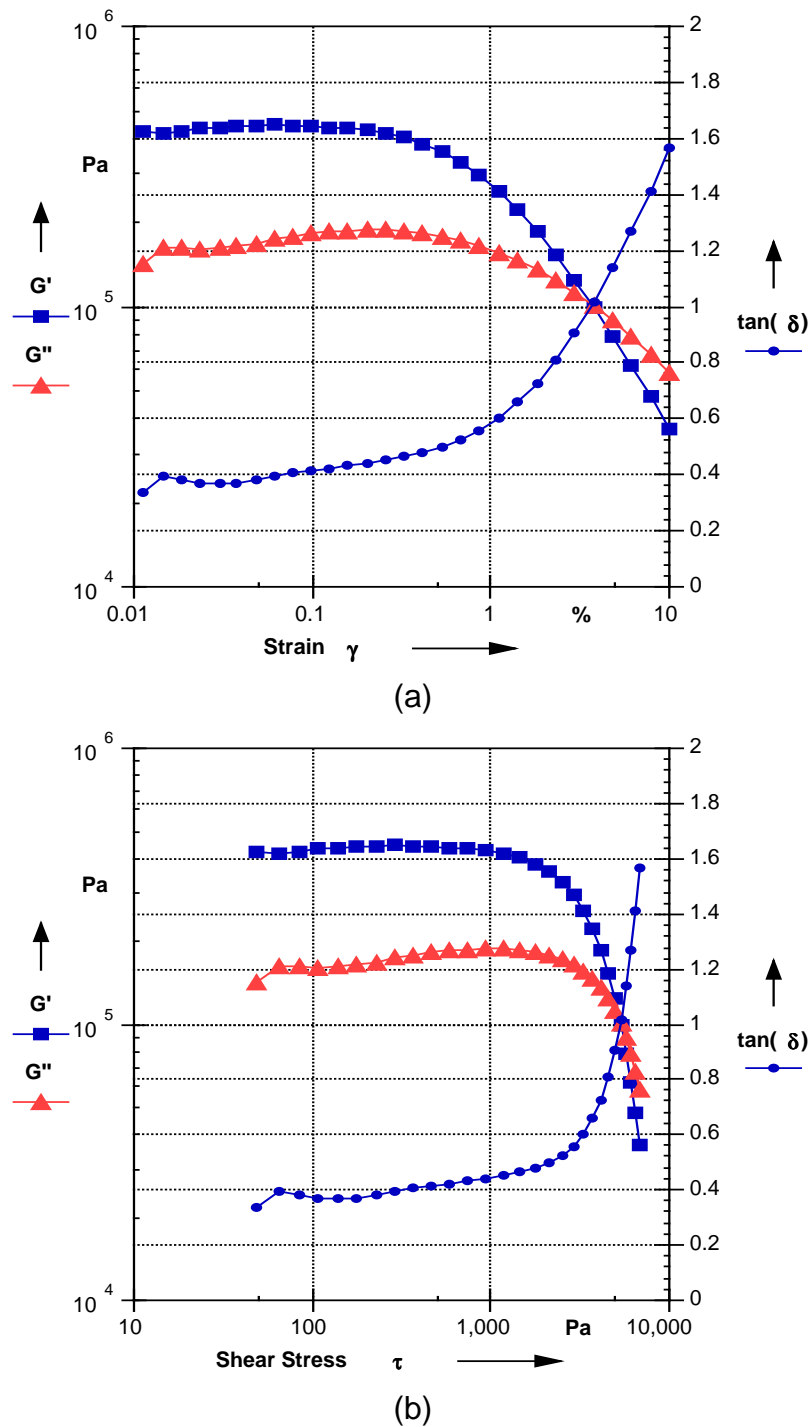

Figure 38 The typical amplitude sweep tests (CSD and CSS) of dental wax No.016 at 60°C. The storage modulus (blue squares),  $G'$ , loss modulus (red triangles),  $G''$ , and loss factor (blue points),  $\tan\delta$ , were plotted against shear strain(a) and shear stress(b), respectively. The angular frequency was fixed at  $\omega = 10 \text{ S}^{-1}$ .

The dominance of  $G'$  indicated that the material behaves primarily in an elastic manner (elastic modulus higher than the viscous modulus), while the shear independence of the moduli showed that the system behavior was unchanged over a range of time scales. Such behavior is characteristic of a physical gel consisting of a three-dimensional network of physical bonds [66, 69, 107]. The network responds elastically at small deformations and the stresses generated do not relax over the time period of the experiments.

#### **4.1.1 Linear viscoelastic range (LVE-range)**

To determine the linear viscoelastic region, the analysis method, "LVE-Range" was selected from the software to analyse the strain sweep tests for all the waxes at each experimental temperature. The strain region was located, in which  $G'$ , and  $G''$  are independent of  $\gamma$  at each measuring temperature. The parameter settings are as follows: As x-variable and y-variable, strain and storage modulus are selected, respectively. To smooth the measurement data prior to the LVE evaluation, the option 'Use Curve Smoothing' was checked, which can avoid errors in the calculation of the end of the linear viscoelastic range. The smoothing range was given as 5% for all calculations. With a tolerance band of 10%, the end point of deformation was estimated as the LVE-range, a critical deformation,  $\gamma_c$ , of all experimental waxes at different temperatures.

The results of the LVE-range analysis include the following parameters: the critical strain level,  $\gamma_c$ , and the corresponding storage modulus ( $G'$ ). All these analyzed parameters are shown from Table 3 to 9 in Appendix 7.6 at different temperatures for each tested dental wax, respectively. Comparisons of these parameters of all dental waxes studied at different temperatures are shown in Figure 39 and 40.



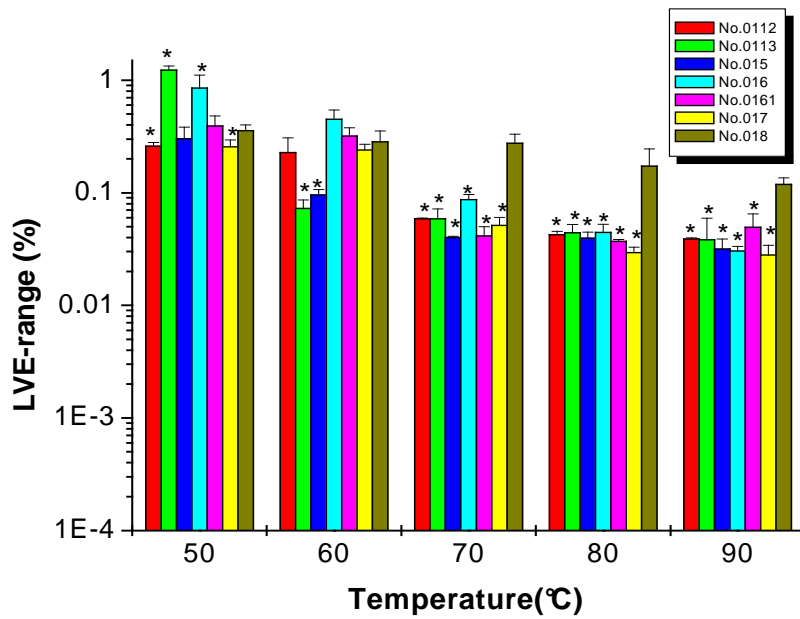

Figure 39 Comparison of LVE range ( $\gamma_c$ ) of all waxes studied at different temperatures (\* $P < 0.05$ )

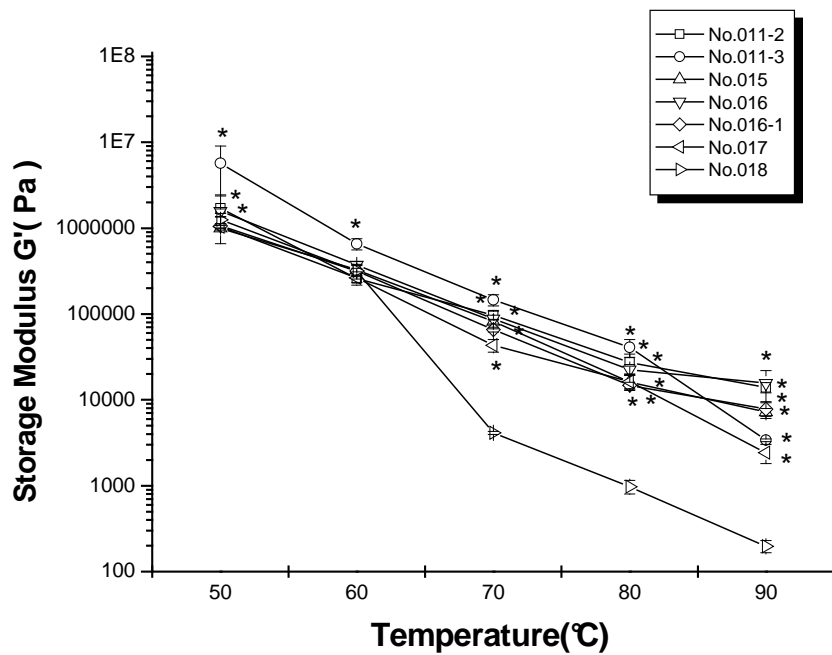

Figure 40 Comparison of the corresponding storage modulus  $G'$  in LVE-range of all waxes studied at different temperatures (\* $P < 0.05$ )

Usually, the rheological properties of a viscoelastic material are independent of strain up to a critical strain level,  $\gamma_C$ , (LVE-range) [6, 14, 15]. The dynamic modulus ( $G'$ ,  $G''$ ) is independent on strain [34, 56]. Beyond this critical strain level, the behavior is non-linear. Structural decomposition or an irreversible destruction of the structure begins and the dynamic modulus decline [6, 11, 14, 81]. Therefore, measuring the strain amplitude dependence of the storage and loss moduli will be very important in characterising viscoelastic behavior.

For all experimental waxes, the limitation of deformation is about between 0.028% and 1.23%(see Table 3 to 9 in Appendix 7.6) at all the tested temperatures. The values of  $\gamma_C$  of all tested waxes are a little higher at 50 and 60°C than that at the other higher temperatures(see Figure 39), which indicates the temperature dependent behaviors of dental waxes. The wider the LVE-range, the stable the structure of materials[11, 35]. With the increasing of temperature, the structures of dental waxes will become weaker. From the diagrams of strain sweep tests, we can also find that mechanical modulus,  $G'$ ,  $G''$ , are a little more stable at 50°C and 60°C than th at at higher temperatures (see Figure 14 to 20 in Appendix 7.3). Changing the temperature from 50°C to 90°C of oscillation induced a decreasing tendency of  $\gamma_C$  for all dental waxes studied. It is more notable for all the new dental waxes than that for the control wax No.018. With wider linear viscoelastic range at higher temperature, the control wax No.018 is more stable than the new experimental waxes. But the corresponding storage modulus,  $G'$ , of wax No.18 in LVE-range decreased much quickly than that of all the new experimental waxes (see Figure 40), which indicated the more decreasing elastic behavior of the control wax.

LVE-range is a good indicator of a wax's brittleness or flexibility. A low value indicates a brittle material while a high value indicates a very flexible one [35, 38, 40]. A strain sweep will establish the extent of the material linearity [6, 11, 14, 81]. These small linear viscoelastic regions are signs of the ability of wax structures to resist external strain to a smaller extent and can not be able to withstand great deformation before rupture [14, 15, 41, 80]. Waxes are very

fragile. These underscore the importance of a sufficiently low strain to ensure a linear response for waxes. Anyway, in the LVE-range, all the waxes showed a behaviour associated with elastic gels.

Being in the linear viscoelastic region in all tested systems, 0.01% was chosen to be applied in the following temperature ramp oscillation tests.

#### 4.1.2 Dynamic modulus of dental waxes at each temperature

The comparisons of diagrams of amplitude sweep among all waxes studied at different temperatures can be found in Appendix 7.3 from Figure 21 to 25 and Appendix 7.4 from Figure 33 to 37. It is very clear that the magnitudes of dynamic modulus of all the new experimental waxes kept in almost the same range at each tested temperature. This indicated that the modulus were insensitive to the type or the slightly different compositions of the new experimental waxes. But only at lower temperature of 50°C and 60°C, the control wax of No.018 has almost the same range of  $G'$  and  $G''$  value (between  $10^5$  Pa and  $10^7$  Pa) with the other new dental waxes (see Appendix 7.3 Figure 21, 22 and Appendix 7.4 Figure 33, 34).

The most significant difference of shear dependent behaviour can be found between the new experimental waxes and the control wax No.018 at higher temperatures. From 70°C, the dynamic modulus  $G'$  and  $G''$  of control wax No.018 decreased very quickly to be about 100Pa at 90°C, whereas all the new experimental waxes displayed relative higher values of both  $G'$  and  $G''$  than No.018, which are about 10 decades larger than that of control wax No.18 at 70°C, 80°C and 90°C (see Appendix 7.3 Figure 23 to 25 and Appendix 7.4 Figure 35 to 37). This indicated the less structure of wax No.018. The analysed results of storage modulus in LVE-range proved also very well to the variations of dynamic properties of dental waxes studied (see Figure 40). The magnitude of  $G'$  is an indication of the density of network bonds in the system [7,35, 45]. A higher value of  $G'$  indicates a denser network and thereby a more rigid gel

structure. Thus, all the new experimental waxes showed a significant more rigid gel structure than the control wax No.018 at higher temperature.

#### **4.1.3 Shear dependent dynamic modulus of dental waxes at different temperatures**

Changes in temperatures show a very clear change of dynamic modulus in shear response of each wax studied. With the increasing of temperature, both of storage modulus ( $G'$ ) and loss modulus ( $G''$ ) had a decreasing tendency for all experimental waxes. The magnitude of dynamic modulus ( $G'$ ,  $G''$ ) of all tested waxes were shifted one decade lower when the temperature increased each 10°C (see Appendix 7.3 Figure 14 to 20 and Appendix 7.4 Figure 26 to 32), which indicated that the shear dependent behaviour of the examined waxes is also temperature dependency. Kotsiomiti E, et al [57] investigated the flow and strength properties of dental waxes following excessive and repeated heatings. They concluded that higher temperatures or repeated heating would affect the composition and properties, resulting in inferior materials. This indicates that it will keep the stable properties of waxes to reduce the reheating and sculpturing times to waxes in dental clinical and technical applications. Certainly, this is also benefit for us to get the more precise dentures. As an example, Figure 41 showed us the decreasing tendency of storage modulus ( $G'$ ) in dependence on temperature of wax No.016 in CSD (a) and CSS mode (b).

An increase in temperature will cause a decrease in elasticity and an increase in viscosity [35, 43]. The analyzed results of LVE-range in Figure 40 also proved the decreasing tendency of dynamic modulus in linear viscoelastic range of dental waxes. Furthermore, when temperatures were higher than 70°C, the control wax No.018 showed a more quickly fallings of storage modulus ( $G'$ ) than the others (see Figure 40). The new dental waxes have more elastic properties at higher temperatures than the control wax No. 018.

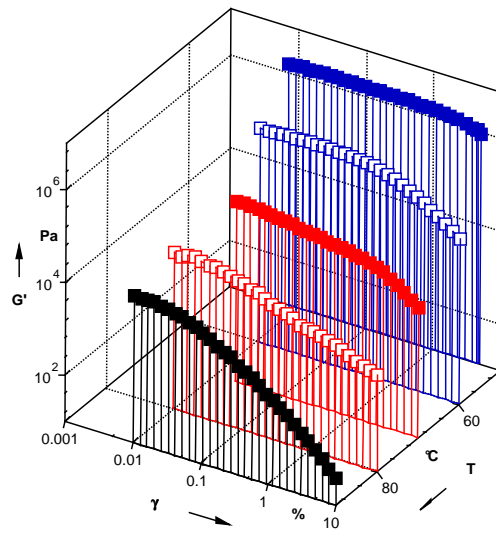

(a)

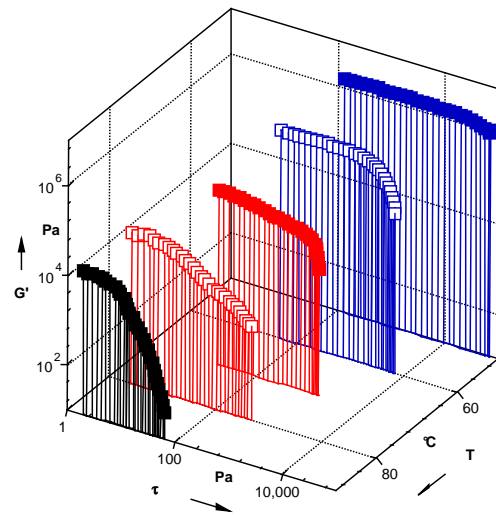

(b)

Figure 41 Shear dependent storage modulus ( $G'$ ) of dental wax No.016 at different temperatures in 3D: (a) CSD mode; (b) CSS mode. The same comparisons of all other dental waxes studied can be found in Appendix 7.3 and 7.4

#### 4.1.4 Gel-to-Sol transition

As the shear strain amplitude increases, the dynamic response becomes non-linear and the decrease of the moduli occurs [34, 35, 43]. At lower tested temperatures of 50°C and 60°C, a different behavior was observed for the loss modulus,  $G''$ , of the dental waxes, above the critical strain amplitude which determines the transition from the linear to the nonlinear regime. As shown in Figure 38, a slight increase of the loss modulus,  $G''$ , was observed, followed by a continuous decrease which was less pronounced than the decrease of the storage modulus,  $G'$ . Such behavior is often found for weak gel structures [59, 108]. The same tendency of dynamic modulus in dependence on the shear stress can also be found in the amplitude sweep (CSS) graphics (see Appendix 7.3 and 7.4).

From amplitude sweep tests (CSS), the relationship of mechanical moduli  $G'$ ,  $G''$  and  $\tan\delta$  with shear stress,  $\tau$ , were measured. The comparisons of typical diagrams of amplitude sweep tests (CSS) of dental waxes at different temperatures were shown in appendix 6.4. The deformation behavior outside the LVE-range was referred to as non-linear. The mechanical modulus,  $G'$  and  $G''$ , would decline, but at different velocity [34, 35, 38, 41, 43, 61]. The decrease of  $G'$  was much faster than that of  $G''$ . Then the value of  $G''$  became larger than  $G'$  ( $\tan\delta > 1$ ). At the stress of crossing over point, the loss modulus,  $G''$ , was equal in value to the storage modulus,  $G'$ , and the loss tangent was 1 [39, 41, 43]. This indicated that there was a gel-to-sol transition of waxes, after which the waxes behaved as a sol [6, 15]. It would therefore be reasonable to assume that some kind of network structure development was taking place [44, 67]. Attention to wax No.011-3 at 50°C, at no time did  $G'$  meet or cross over  $G''$  in the measuring range (see Figure 27 and 33 in Appendix 7.4), indicating no networking and a stronger wax structure at this temperature [33, 35].

The intercept point was calculated for each experimental wax at every tested temperature. Here, the two parameters, stress ( $\tau$  value) and storage modulus ( $G'$ ) were analyzed. The results were shown from Table 10 to 16 in Appendix 7.7, respectively. The statistic analysis of  $\tau$  (stress) value and storage modulus,  $G'$ , of all tested waxes at different temperatures were illustrated in Figure 42 and 43.

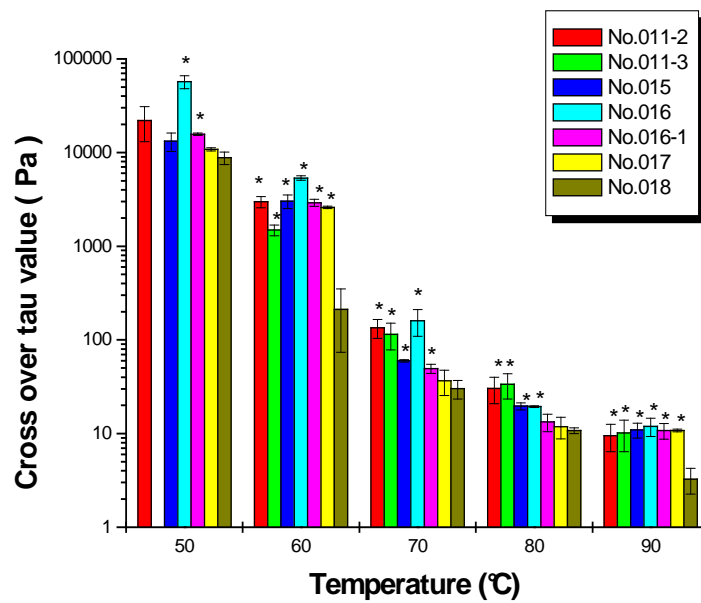

Figure 42 The variation of tau values at crossover point by amplitude sweep tests(CSS) of all waxes studied at different temperatures (\* $p < 0.05$ )

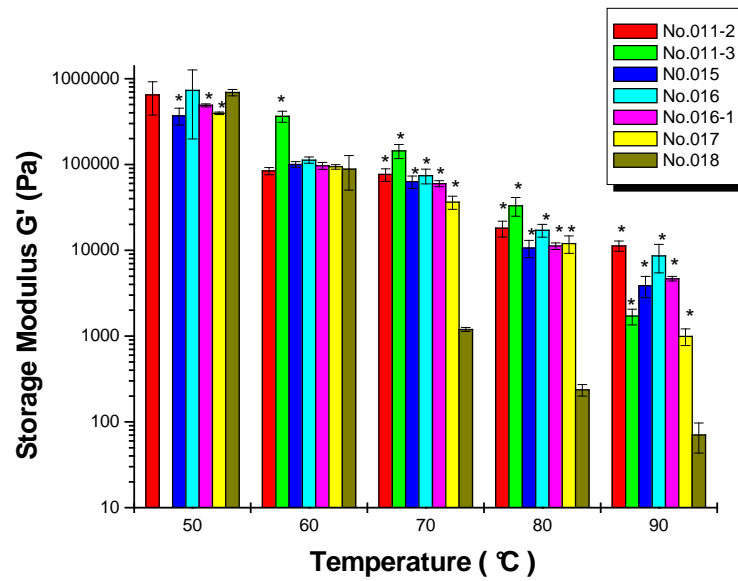

Figure 43 The variation of storage modulus  $G'$  values at crossover point by amplitude sweep tests (CSS) of all dental waxes studied at different temperatures (\* $p < 0.05$ )

With the increasing of temperature, each wax tends to decrease both of tau value and storage modulus at the crossing over point. The decrease of the tau value(stress) at the crossing over point is a sign of pronounced viscous properties [65, 73, 83, 93]. The elastic properties of the tested waxes were strongly decreased with the increasing of temperature. Waxes were very temperature sensitive materials [52, 57, 75, 76, 86]. It was in agreement with the variation of storage modulus,  $G'$ , which represents the elastic behavior of a sample [7, 93]. Compare the new experimental waxes to the control wax No.18, at each tested temperature, all the new experimental waxes had both the greater values of stress and storage modulus at the intercept point. Great crossing over point tau values are signs of the ability of structures to resist external stresses to a greater extent [56, 69]. This indicated that the new experimental waxes had more lasting of elastic behaviors under increasing stress than wax No.018 at each tested temperature, especially at higher temperatures, which agreed very well with the analyzed results of LVE-range.



Compare with control wax No.018, the dynamic modulus,  $G'$ ,  $G''$ , in dependent on shear stress of all the new dental waxes were more stable from 60°C (see Appendix 7.4 from Figure 34 to 37). At lower stress value, the dynamic modulus,  $G'$ ,  $G''$ , were already declined for wax No.018. For example, At 60°C, all the new dental waxes showed the independent dynamic modulus to a stress value about 1000Pa. But for wax No.018, this stress value was only about to 250Pa (Appendix 7.4, Figure 34). And with the increasing of temperature, this stress value became more smaller for control wax No.018. This illustrated the stronger structures of new dental waxes studied and the different melting ranges between the new dental waxes and control wax No.018. The new experimental waxes could withstand larger shear stresses and keep their internal-structures. They are more flexible in clinical and technical application than the control wax No.018.

## 4.2 Effect of temperature on mechanical properties

The temperature dependence of dynamic moduli  $G''$ ,  $G'$  and  $\tan\delta$  of dental waxes were measured through the temperature ramp oscillation tests in linear viscoelastic range. The typical diagrams of temperature ramp oscillation tests conducted at 0.01% strain rate, angular frequency  $10\text{ S}^{-1}$  of all dental waxes studied were shown from Figure 44 to 49 in Appendix 7.5, and summarized into the following graphics (Figure 50 and 52), which illustrated magnitude of dynamic moduli  $G''$ ,  $G'$  and  $\tan\delta$  of dental waxes studied as a function of temperature, respectively.

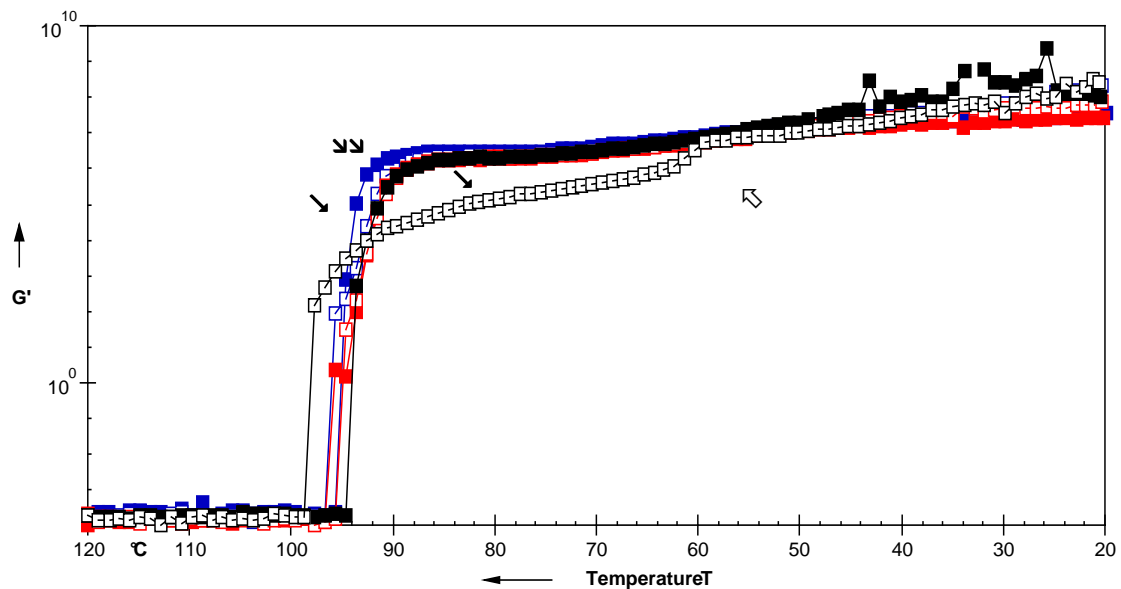

Figure 50 Storage modulus ( $G'$ ) as a function of temperature for all dental waxes studied from temperature ramp oscillation tests in a cooling process. Tests were presetted as follows: constant angular frequency:  $10\text{ S}^{-1}$ , constant strain: 0.01% in LVE-range, temperature range: 120-20°C, cooling rate: 1°C/min. No.011-3(blue filled); No.015(blue empty); No.016(red filled); No.016-1 (red empty); No.017(black filled); No.018(black empty).

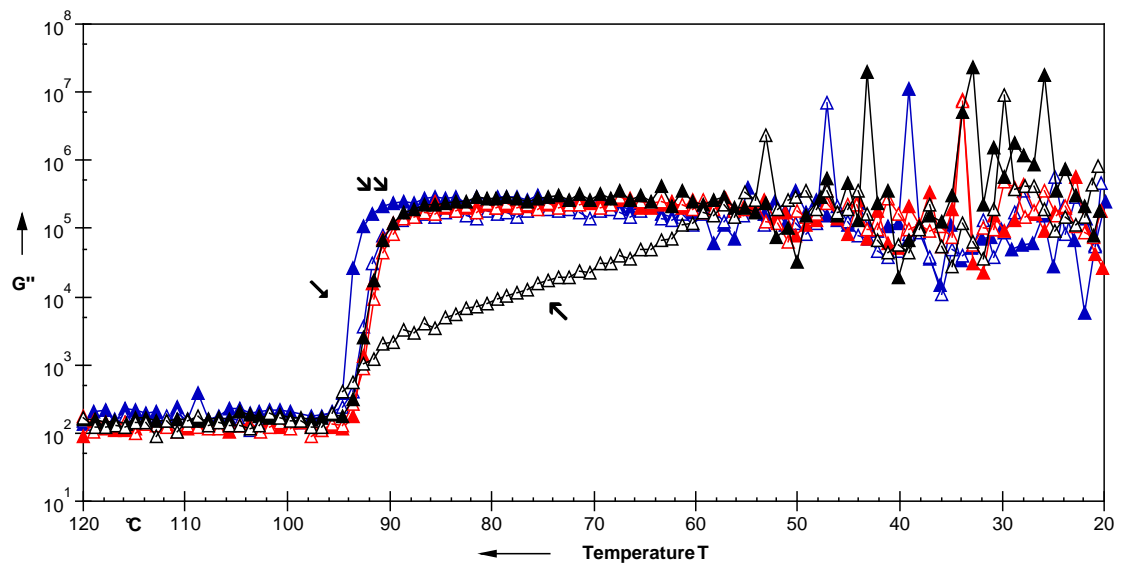

Figure 51 Loss modulus ( $G''$ ) as a function of temperature for all dental waxes studied from temperature ramp oscillation tests in a cooling process. Tests were presetted as follows: constant angular frequency:  $10\text{S}^{-1}$ , constang strain: 0.01% in LVE-range, temperature range: 120-20°C, cooling rate:  $1^\circ\text{C}/\text{min}$ . No.011-3(blue filled); No.015(blue empty); No.016(red filled); No.016-1(red empty); No.017(black filled); No.018(black empty).

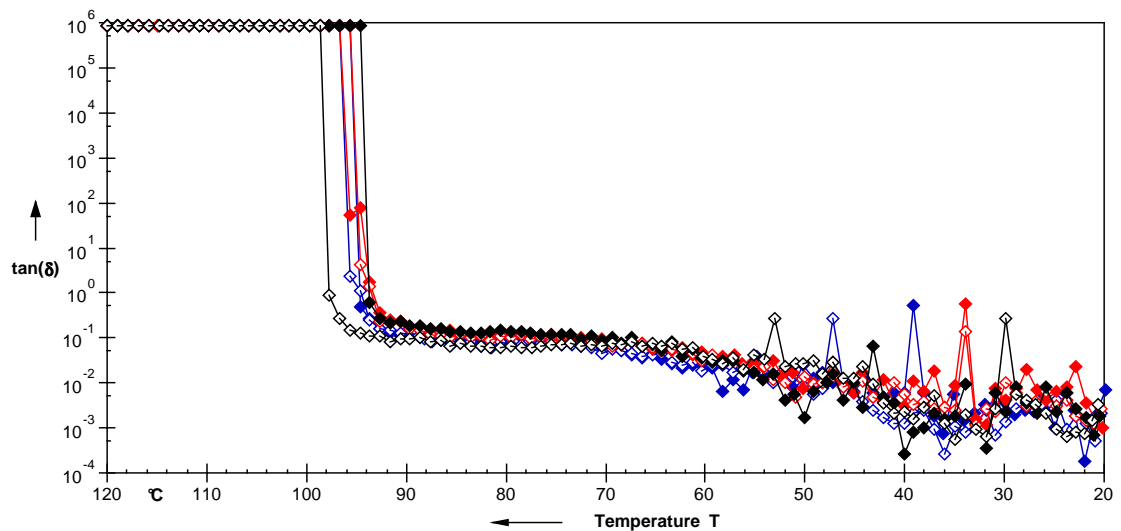

Figure 52 Dynamic loss factor ( $\tan\delta$ ) as a function of temperature for all dental waxes studied from temperature ramp oscillation tests in a cooling process. Tests were presetted as follows: constant angular frequency:  $10\text{S}^{-1}$ , constang strain: 0.01% in LVE-range, temperature range: 120-20°C, cooling

rate: 1°C/min. No.011-3(blue filled); No.015(blue empty); No.016(red filled); No.016-1(red empty); No.017(black filled); No.018(black empty).

#### 4.2.1 Temperature dependence of the dynamic modulus

Referring to the typical diagrams of temperature sweep tests of dental waxes in Appendix 6.5, at first glance, all the tested dental waxes had almost the same outline image in temperature ramp oscillation tests. In the beginning of the cooling procedure, the magnitudes of loss modulus,  $G''$ , of all waxes were much greater than that of storage modulus,  $G'$ , and both were constant. The corresponding  $\tan\delta$  had a much great value (about  $10^6$  Pa) (see Figure 50–52). These indicated an almost ideal liquid characteristic/sol state of dental waxes at high temperatures.

With the decreasing of temperature, both the two dynamic modulus increased. But the relationship between them reversed. It happened to each tested wax (see Appendix 7.5). This was due to the crystallization of dental waxes in the cooling procedure, which will induce the the abrupt changes of mechanical modulus of waxes [70, 71, 73, 82, 84]. After the intersection point, both the storage modulus and loss modulus gradually increased. But the new dental waxes had a much greater increasing speed of these parameters than the control (see the single black arrows in Figure 51 and 52). These indicated that gel formed immediately and completely for the new experimental waxes, no significant induction time was observed. The melting ranges of all the new dental waxes are smaller than the control. This could be due to the different chain natures compared to control wax. In shorter time, the new dental waxes could become more rigidity than the control No.018, and the distortion of waxes would be minimized.

For wax No.011-3, it was the first which achieved a relative higher magnitudes of storage modulus,  $G'$ , and loss modulus,  $G''$ , in the cooling process (see the double black arrows in Figure 50 and 51). This showed the smallest melting

range of wax No.011-3 among all the waxes studied. It was due to the absence of hydrocarbon wax with microcrystalline structure in this wax. This component would be crystallized in the cooling procedures. Much more crystallization could delay the melting process of waxes [26].

With the decreasing of temperature, wax No.017 showed the relative greater magnitudes of dynamic modulus at lower temperatures, although wax No.01-3 was the first wax which achieved a relative higher magnitude of mechanical modulus(see Figure 50, 51). It was due to the relative more component of hydrocarbon wax (with microcrystalline structure). The more crystalline structure, the stronger the structure [10, 39, 44]. On cooling process, the crystalline changes of hydrocarbon waxes will influence the mechanical properties of waxes. More microcrystalline structure will severely enhance the recrystallization in the cooling process for waxes [75].

It is worthy of noting that, from the converting point to about 50°C, all the new experimental dental waxes had higher values of dynamic modulus( $G'$ ,  $G''$ ) than the control wax No.018. Because of the lower  $G'$  value of control wax in this temperature range, the control wax No.018 was not too rigid compared to all the new dental waxes. The control wax is less structure. The variations of dynamic modulus from temperature ramp oscillation tests agreed very well with that from amplitude sweep tests. With greater mechanical modulus, the new experimental waxes will be more flexible for the clinical practice. Additionally, as can be seen in Figure 52, although the variations of  $\tan \delta$  of all the tested waxes were almost in the similar pattern, the new experimental waxes still displayed a little higher values of  $\tan \delta$  than the control of No. 018 in the cooling period about 100°C–68°C, indicating a little more elastic characteristics of new waxes.

Noticing another special point of the increasing of storage modulus,  $G'$ , of control wax No.018 at about 60°C (see Figure 49 in Appendix 7.7 and the empty arrow in Figure 50), we can conclude that in this wax there are another specific ingredients, which melted at about 60°C.

### 4.2.2 Gel point

In theory, the criterion of gel formation is the existence of one long chain running through the whole system; i.e., its molar mass becomes infinite. In practice, a sudden loss of flow is the most common and conventional test to determine the sol-gel transition point since at the gelation point the viscoelastic properties change abruptly from an initially liquid-like state to a solid-like state [5, 26, 42, 44, 69, 90, 110]. The network structure can be formed by either a chemical or a physical gelation process. The formation of the gel network will influence the mechanical properties of materials [10].

To a special temperature, both  $G''$  and  $G'$  started to increase precipitously, suggesting that these branched macromolecules or clusters had just been connected into a three-dimensional network percolating into the entire space [3, 70, 100, 107]. Meanwhile, the increasing speeds of  $G'$  were much more quickly than  $G''$ , the relationship between  $G''$  and  $G'$ , was suddenly reversed and  $\tan\delta$  became smaller than 1. The use of  $\tan\delta$ , evaluating network characteristics, has the advantage of incorporating the contributions of both  $G''$  and  $G'$  into a single parameter to evaluate the final network [33, 40]. Changes in  $\tan\delta$  reflected a transition of the viscous wax sol to the elastic wax gel, which correlated to the changes of  $G''$  and  $G'$  observed during cooling [6, 7, 15]. The sol-gel transition point can be determined by a sudden change of a range of physical properties [14, 90]. This special temperature was recognized as the gel temperature (see Figure 50-52), indicating the sol-gel transition of dental waxes, also the loss of fluidity and the appearance of elasticity [110].

The analysed data of gel temperature of all tested waxes were illustrated in Figure 53. The values of gel temperatures of all the new experimental waxes were between 93,29°C-94.37°C. This indicated that the different compositions of the new experimental waxes had minor effect on the gelation.

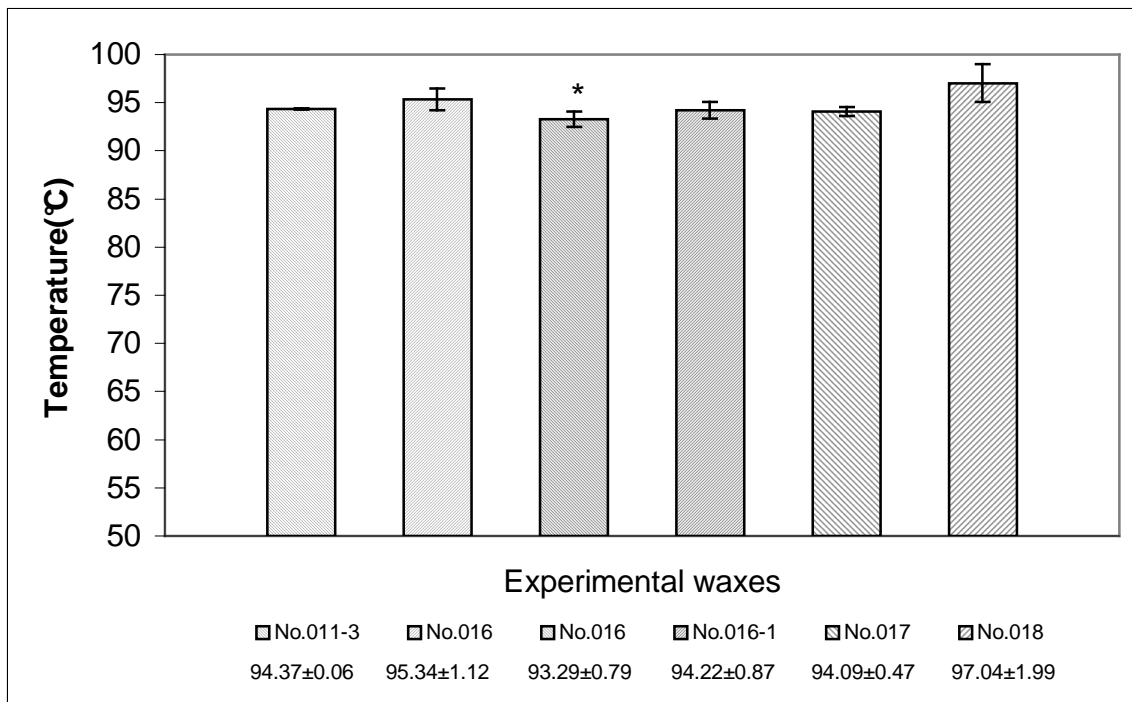

Figure 53 Comparisons of gel temperatures of different waxes from temperature ramp oscillation sweep tests at constant strain of 0.01% and angular frequency of 10 1/s from 120-20°C, cooling rate 1°C/min. Each value represents the mean( $\pm$ SD) of three replicates (\* $p < 0.05$ )

A little earlier converting time of control wax No.018 indicated a slight higher gel temperature (mean 97,04°C) than that of all other tested waxes (from 93,29°C to 94.37°C) (see Figure 51, 52 and 53). At the later stage, storage modulus,  $G'$ , of dental waxes became gradually greater than loss modulus,  $G''$ , and the loss factor displayed a decreasing tendency. This was a stage where the three-dimensional network further developed. These indicated the increasing domination of gel properties of dental waxes, “gel strengthening” [38, 103, 107]. This result agreed well with the amplitude sweep tests (CSS).

When the temperature was lower than 50 degree C, all these parameters became a little distorted, which was due to the very strong rigidity of waxes at lower temperature. At temperature higher than 100°C, the wax are already fluidized. There would be very little elastical characteristics for waxes and

storage modulus,  $G'$ , was very difficult to be measured correctly, especially in shear conditions. These findings were also an evidence of the suitable temperature range of rheological measurements for waxes, which was between 50°C and 90°C. It corresponded very well to my primary temperature hypotheses of the amplitude sweep tests of dental waxes. It is also consistent with the temperature range between 55°C and 100°C, reported by Niles, J.C [74].



## 5. CONCLUSIONS

The present study employed a Rheometer to characterize the viscoelastic properties of dental waxes. Dynamic oscillatory experiments showed that the shear strain limit for linear viscoelastic behavior of dental waxes decreased with increasing temperature. Due to the very small LVE-range, the temperature sensitive dental waxes can not withstand higher shear conditions. The slightly different composition of new experimental waxes has minor influence to the dynamic modulus. With higher stress ( $\tau$ ) values and storage modulus at the intercept point except for the control, all the new experimental waxes showed more rigid gel structure than the control wax. The new experimental waxes could withstand larger shear stresses and keep their internal-structures. The distortion of these waxes would be minimized. Applying the new experimental waxes will reduce the inaccuracies in dental practices. Temperature ramp oscillation tests showed a relative lower gel temperature and small melting range of the new experimental dental waxes. These results indicate that we can get more precise contours of dentures at relative lower temperature and time shortening through the application of new experimental waxes. The experimental waxes would be more flexible and easier to be handled than the control to clinical and technical job in hand. The suitable temperature range of rheological measurements for dental waxes is between 50°C and 90°C. Based on this study, further work should be looked at the viscoelastic properties of these experimental dental waxes at lower temperatures for dental clinical applications.

## 6. Summary

### *Objectives*

The purpose of this study was to evaluate the rheological behaviour of new experimental dental waxes in dependent on temperature.

### *Material and method*

Seven experimental dental waxes, provided by Dentaurum GmbH, were tested. No.018 was chosen as a control. Rheological experiments were performed at different temperatures using a Paar Physica Rheometer UDS200 equipped with a parallel plate cell. The temperature was regulated with a Peltier system (TEK130P) and a thermostat unit(Julabo). Small strain sweep tests were used to evaluate the linear viscoelastic range (LVE-range) with an interval of 10°C in the temperature range of 50°C-90°C. Stress sweep and temperature oscillation tests were carried out to ascertain the dependence of storage modulus  $G'$ , loss modulus  $G''$  on shear stress and temperature. All the tests were done at least in triplicate for each wax and all measurements were made from separate samples. The data were identified by T-test to show whether there were significant differences between new experimental waxes and control wax No.018 at the 95% confidence level.

### *Results*

For all experimental waxes, the limitation of deformation is about between 0.028% and 1.23% at all the tested temperatures. The  $\gamma_c$  values of all tested waxes are a little higher at 50°C and 60°C than that at the other higher temperatures, which indicates the temperature dependent behaviors of dental waxes. The small LVE-range are signs of the ability of wax structures to resist external strain to a smaller extent and can not withstand great deformation before rupture. Waxes are very fragile. Anyway, in the LVE-range, all the waxes

showed a behaviour associated with elastic gels. Being in LVE-range, 0.01% was chosen to be applied in the following tests. Meanwhile, the analyzed results of LVE-range also proved the decreasing tendency of dynamic modulus in LVE-range of dental waxes. Furthermore, when temperatures were higher than 70°C, the control wax No.018 showed a more quickly fallings of storage modulus ( $G'$ ) than the others. The new dental waxes have more elastic properties at higher temperatures than the control.

The deformation behavior outside the LVE-range was referred to as non-linear. The mechanical modulus would decline, but at different velocity. At the stress of crossing over point, the loss modulus,  $G''$ , was equal to the storage modulus,  $G'$ , and the loss tangent was 1. This indicated that there was a gel-to-sol transition of waxes, after which the waxes behaved as a sol. Compare with No.018, the shear stress dependent dynamic modulus ( $G'$ ,  $G''$ ) of all the new dental waxes were more stable than that of the control.

The diagrams of temperature ramp oscillation tests demonstrated the variations of mechanical modulus in the cooling procedures of all tested waxes. When the wax was cooled to a special temperature, both the two dynamic modulus increased. But the relationship between them reversed. But the new dental waxes had a much greater increasing speed of these parameters than the control, which indicated that gel formed immediately and completely for the new experimental waxes, no significant induction time was observed. The melting ranges of all the new dental waxes are smaller than the control. A little earlier converting time of control wax No.018 indicated a slight higher gel temperature (mean 97,04°C) than that of all other tested waxes (from 93,29°C to 94.37°C). This small range indicated that the different compositions of the new experimental waxes had minor effect on the gelation.

### *Conclusions*

The slightly different composition of new waxes has minor influence to the dynamic modulus. Temperature sweep showed a relative lower gel point and

small melting range of new dental waxes. Applying the new experimental waxes will reduce the inaccuracies in dental practices. The experimental waxes would be more flexible and easier to be handled than the control to clinical and technical job in hand. The suitable temperature range of rheological measurements for dental waxes is between 50°C and 90°C. Based on this study, further work should be looked at the viscoelastic properties of these experimental dental waxes at lower temperatures for dental clinical applications.

## 7. Appendix

### 7.1 Nomenclature

$\delta$	phase angle
$\eta$	shear viscosity
$\gamma$	shear strain (deformation)
$\eta^*$	complex viscosity
$\omega$	angular frequency
$\dot{\gamma}$	shear rate
$G'$	storage modulus
$G''$	loss modulus
$G^*$	complex modulus
$T$	absolute temperature
$\tan \delta$	loss factor
$\varphi$	displacement
$M$	torque
$t$	time
$F_N$	Normal force
$\lambda$	relaxation time

## 7.2 Operating Procedures of UDS200

- Open the computer
- Turn on the compressed air dryer
- Open the Rheometer
- Open the MC200 V.2,43
- Initialize the rheometer
- Zero gap setting
- Open a new workbook
- Open a new measuring window
- Choose a measurement
- Name the workbook and measuring window
- Choose the measuring system
- Choose the Peltier
- Pre-setting the parameters(notice: the exact measuring gap and temperature in all tested intervals)
- Switch on the thermostat and enter the desired temperature as set point
- Send the temperature
- Lift position
- Deposite the specimens directly onto the lower (Peltier) plate at once  
(Notice: change the specimen every time)
- Measuring Gap setting
- Cleaning the excess wax samples from the outer edge of the gap
- Cover the wax sample with a insulating cover to prevent temperature loss while carrying the test
- Profile test
- Click the start button ( ► ) on the upper right side of the computer screen.  
This will allow you to enter the following important setting:
  - 1) Information Texts and Start:
    - Date series name; Sample; Operator; Remark of the test

- 2) Temperature Setting: The option 'Set Temperature before starting the Test'  
was chosen and the tested temperature was given
  - 3) Waiting before Starting Test:  
Choose the option "with waiting time" and preset it as 10 minutes
  - 4) Data Settings: Choose the "Replace data series with the same name"  
in  
"Naming of Data Series"
- After making sure everything is ready, click "Start the Test Now" button

### 7.3 Summarized Diagrams of Amplitude Sweep Tests (CSD)

Appendix 7.3 illustrates the summarized diagrams of amplitude sweep tests (CSD) of all the dental waxes studied.

#### 7.3.1 Comparisons of each wax at all tested temperatures

The legends are as follows:

50°C (■G'▲G''); 60°C (□G'△G''); 70°C (■G'▲G''); 80°C (□G'△G''); 90°C (■G'▲G'')

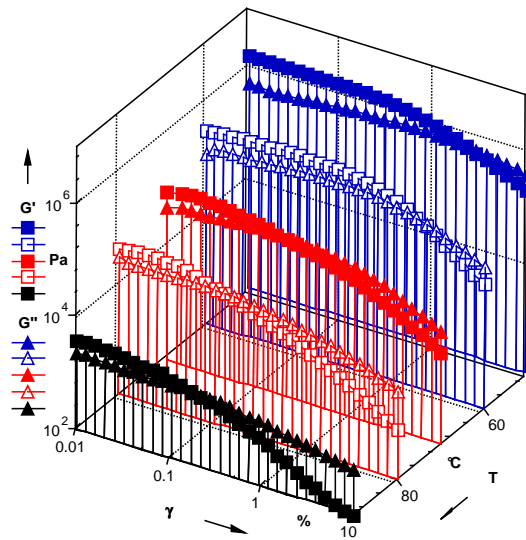

Figure 14 Amplitude sweep tests (CSD) of wax No.011-2 at different temperatures



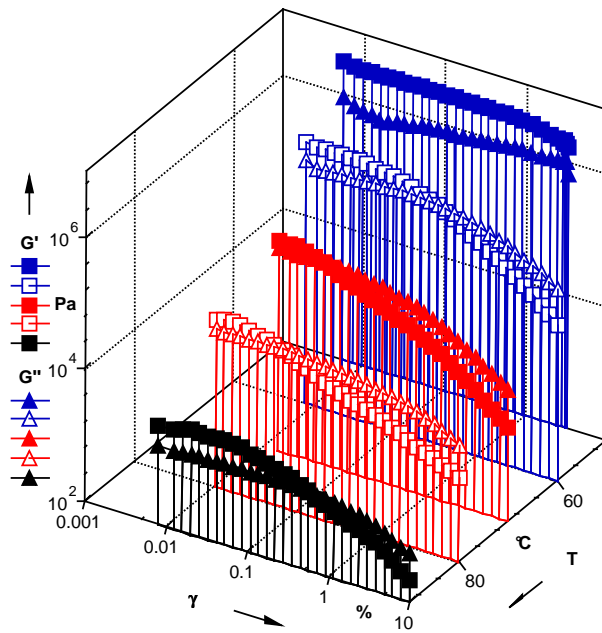

Figure 15 Amplitude sweep tests (CSD) of wax No.011-3 at different temperatures

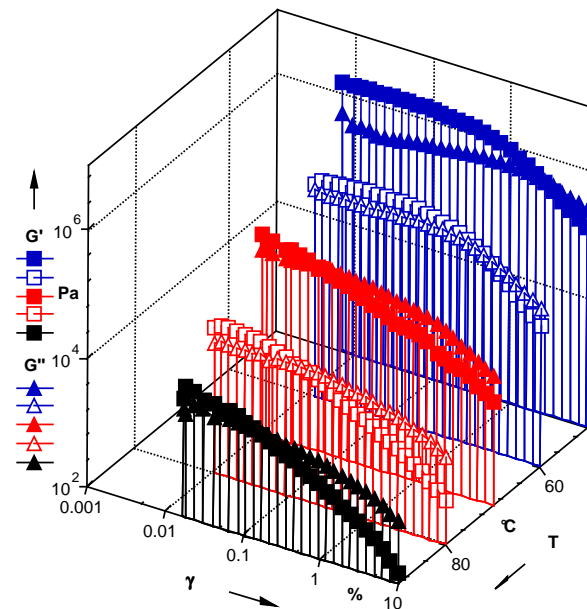

Figure 16 Amplitude sweep tests (CSD) of wax No.015 at different temperatures

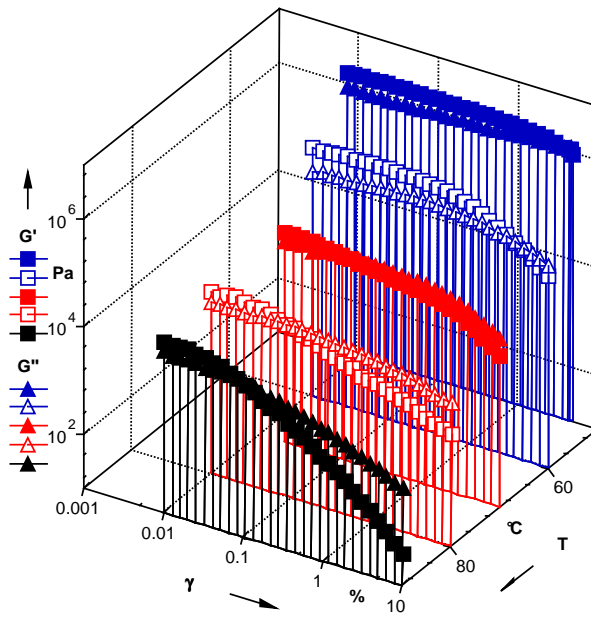

Figure 17 Amplitude sweep tests (CSD) of wax No.016 at different temperatures

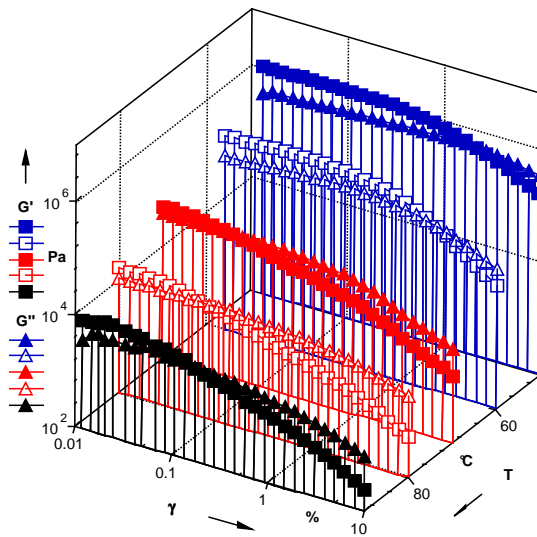

Figure 18 Amplitude sweep tests (CSD) of wax No.016-1 at different temperatures

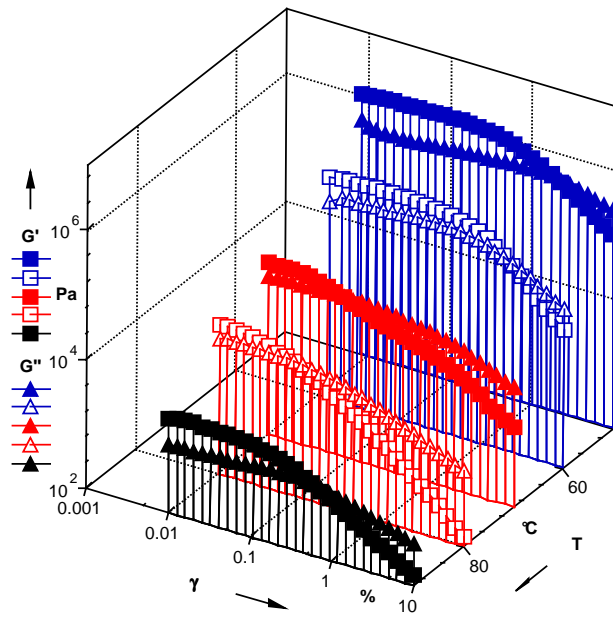

Figure 19 Amplitude sweep tests (CSD) of wax No.017  
at different temperatures

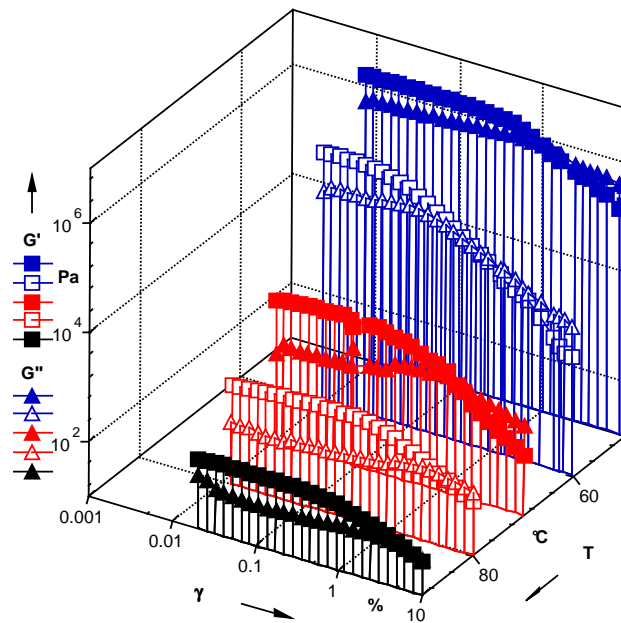

Figure 20 Amplitude sweep tests (CSD) of wax No.018  
at different temperatures

### 7.3.2 Comparisons of all waxes at each temperature

The legends are as follows:

No.011-2(■G'▲G''); No.011-3(□G'△G''); No.015(■G'(G'')); No.016((G'(G''));  
No.016-1((G'(G'')); No.017(□G'△G''); No.018(■G'▲G'')

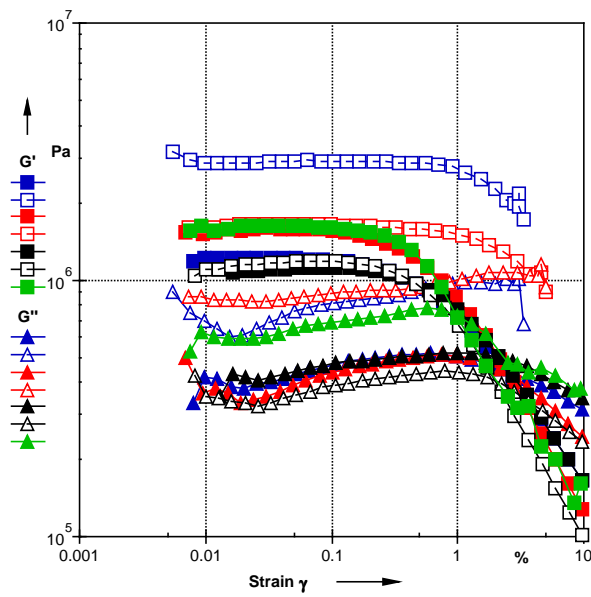

Figure 21 Comparison of amplitude sweep tests (CSD) of different waxes studied at 50°C

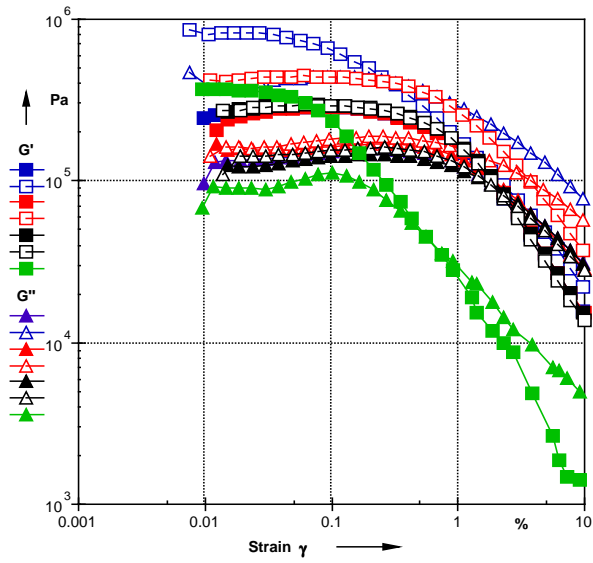

Figure 22 Comparison of amplitude sweep tests (CSD) of different waxes studied at 60°C

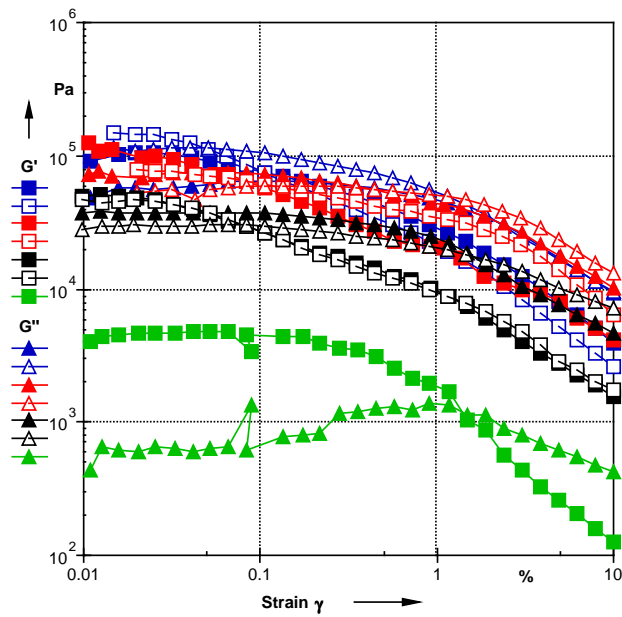

Figure 23 Comparison of amplitude sweep tests (CSD) of different waxes studied at 70°C

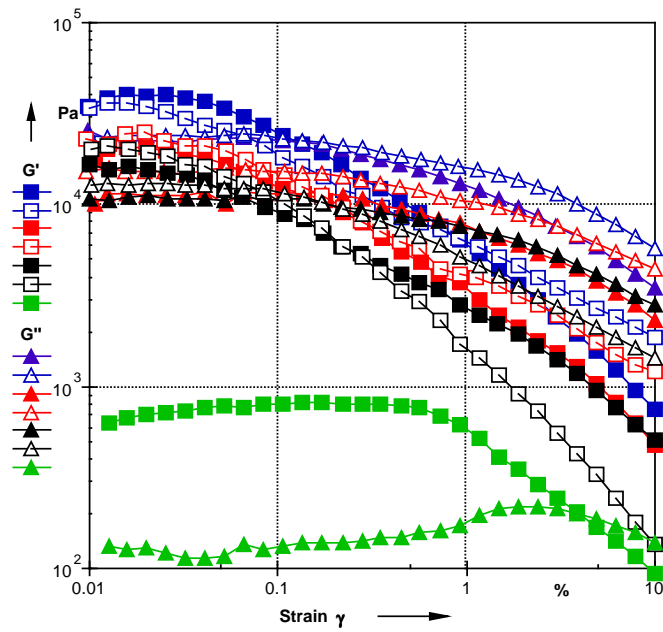

Figure 24 Comparison of amplitude sweep tests (CSD) of different waxes studied at 80°C

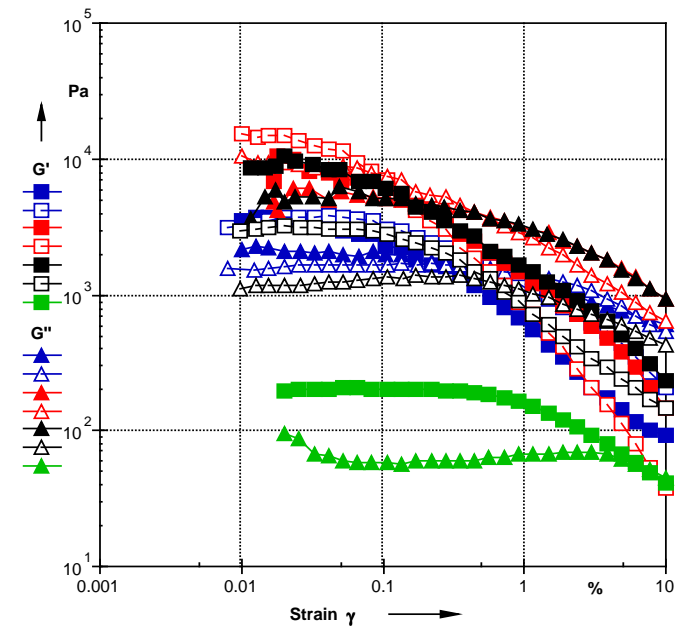

Figure 25 Comparison of amplitude sweep tests (CSD) of different waxes studied at 90°C

## 7.4 Summarized Diagrams of Amplitude Sweep Tests (CSS)

Appendix 7.4 illustrates the summarized diagrams of amplitude sweep tests (CSS) of all the dental waxes studied.

### 7.4.1 Comparisons of each wax at all tested temperatures

The legends are as follows:

50°C (■G'(G'')); 60°C(□G'(G'')); 70°C(△G'(G'')); 80°C(□G'(G'')); 90°C(△G'(G''))

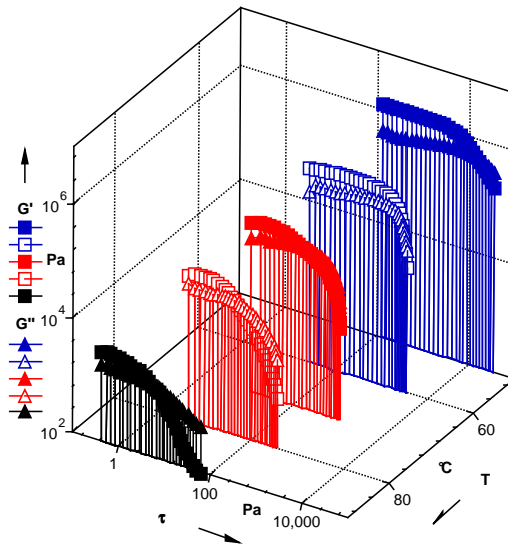

Figure 26 Amplitude sweep tests (CSS) of wax No.011-2 at different temperatures

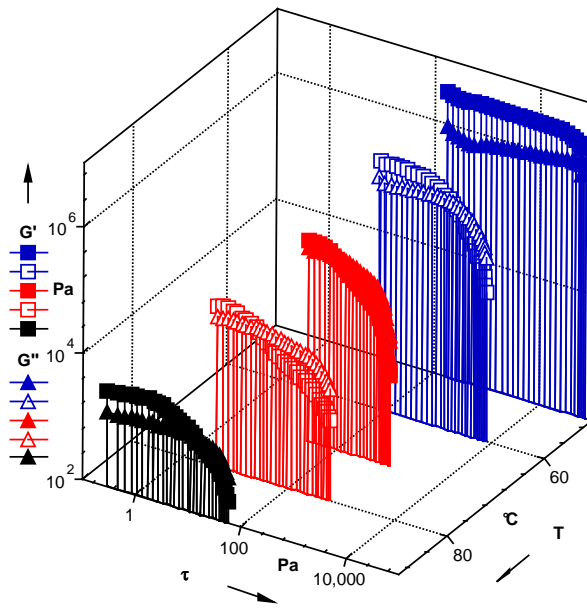

Figure 27 Amplitude sweep tests (CSS) of wax No.011-3 at different temperatures

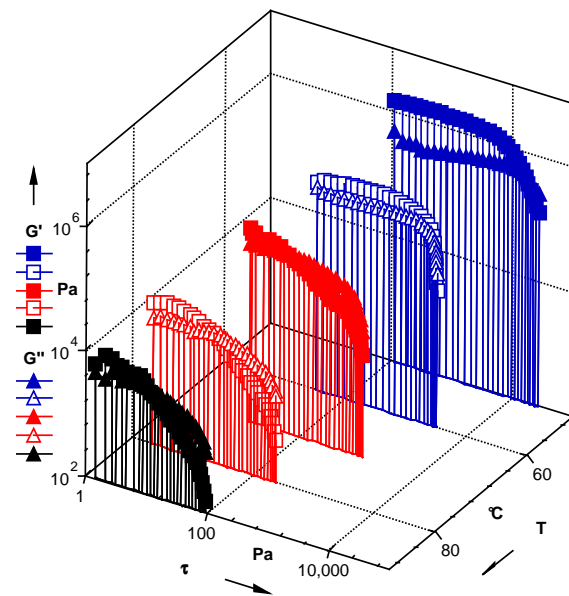

Figure 28 Amplitude sweep tests (CSS) of wax No.015 at different temperatures



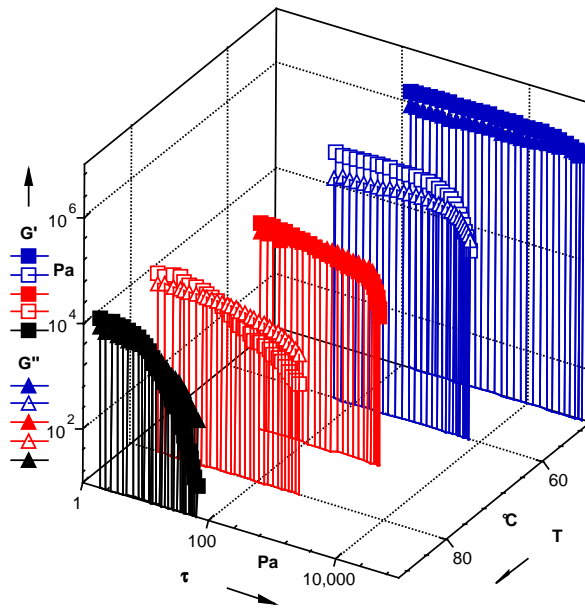

Figure 29 Amplitude sweep tests (CSS) of wax No.016 at different temperatures

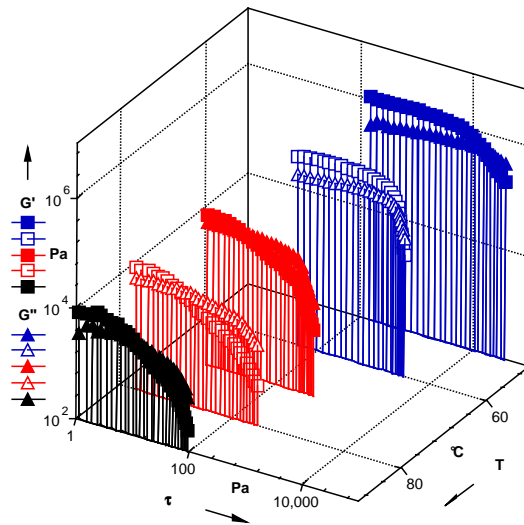

Figure 30 Amplitude sweep tests (CSS) of wax No.016-1 at different temperatures

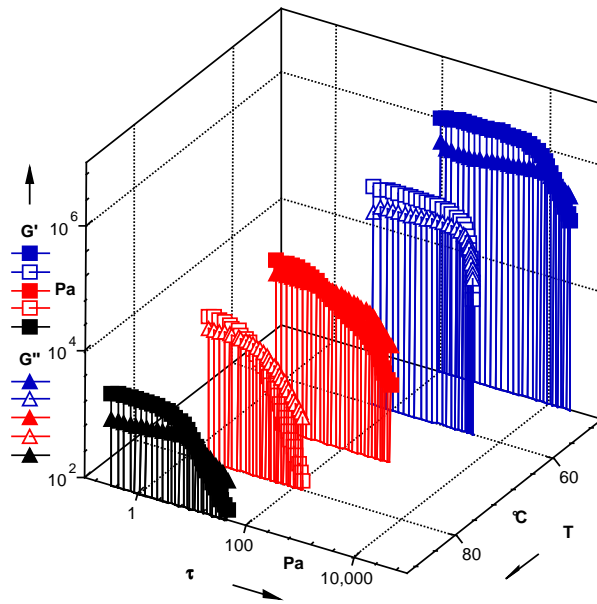

Figure 31 Amplitude sweep tests (CSS) of wax No.017 at different temperatures

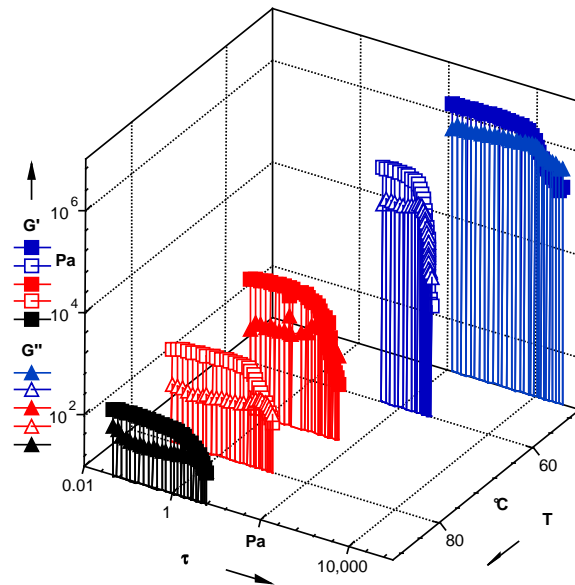

Figure 32 Amplitude sweep tests (CSS) of wax No.018 at different temperatures

### 7.4.2 Comparisons of all wax at each tested temperatures

The legends are as follows:

No.011-2(■G'(G''); No.011-3(□G'(G''); No.015 ((G' ▲G''); No.016(□G' ▲G'');

No.016-1(■G' ▲G''); No.017(□G' ▲G''); No.018 (■G' ▲G'')

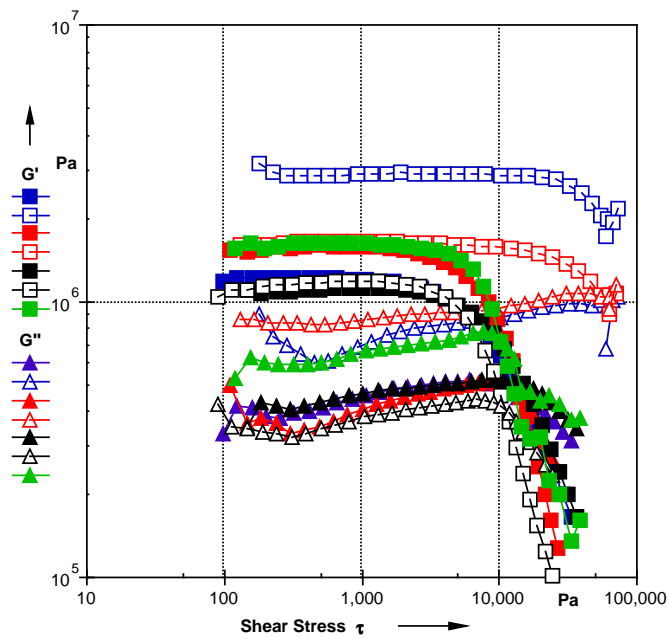

Figure 33 Comparison of amplitude sweep tests (CSS) of different waxes studied at 50°C

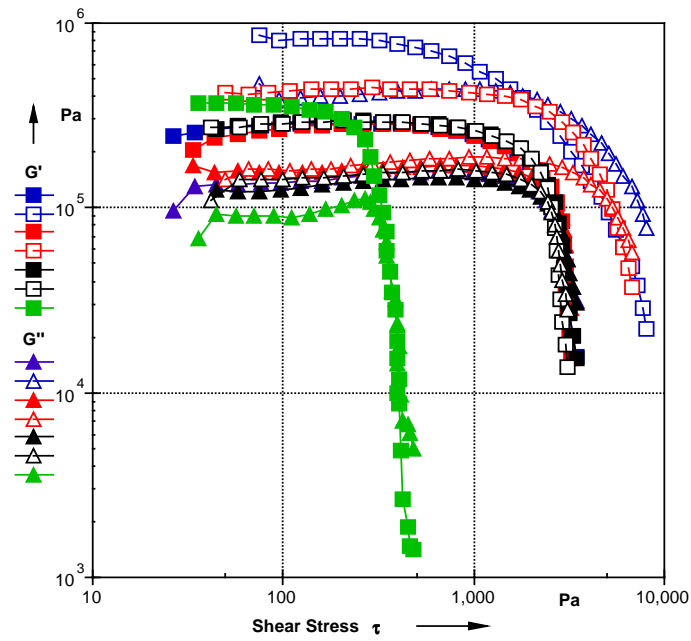

Figure 34 Comparison of amplitude sweep tests (CSS) of different waxes studied at 60°C

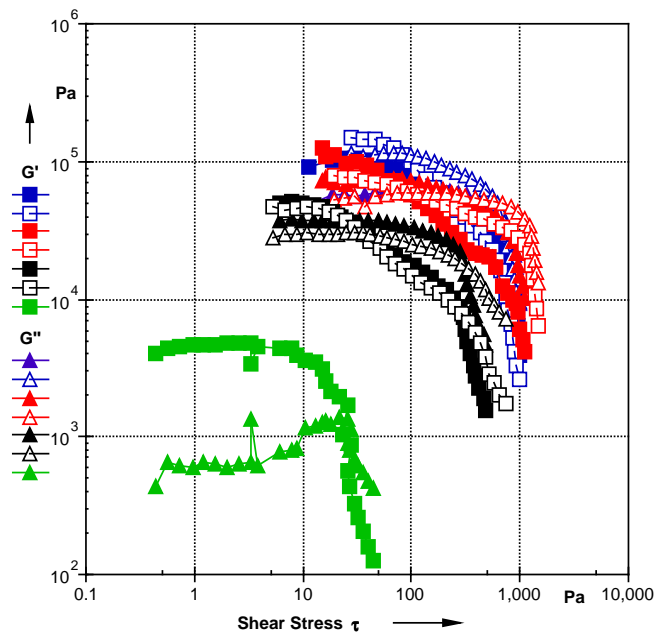

Figure 35 Comparison of amplitude sweep tests (CSS) of different waxes studied at 70°C

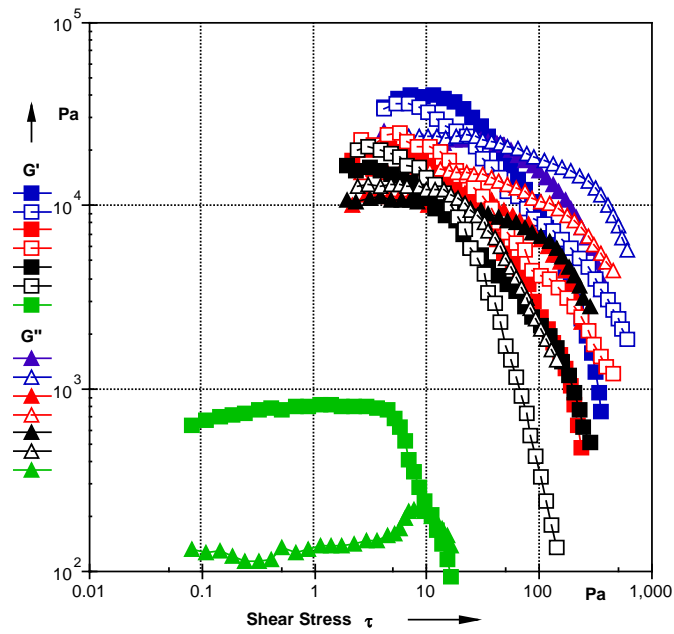

Figure 36 Comparison of amplitude sweep tests (CSS) of different waxes studied at 80°C

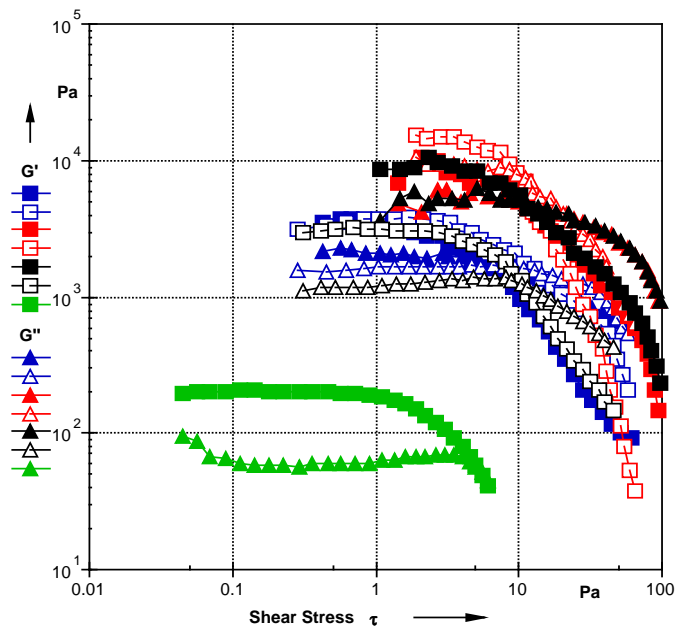

Figure 37 Comparison of amplitude sweep tests (CSS) of different waxes studied at 90°C

## 7.5 Typical Diagrams of Temperature Ramp Oscillation Tests

Appendix 7.5 illustrates the typical diagrams of Temperature Ramp Oscillation Tests of all the dental waxes studied. Tests were performed at a constant strain of 0.01%, which lied in LVE-range of all dental waxes. The angular frequency was presettted as a constant value of  $10\text{S}^{-1}$ , which is the same as amplitude sweep tests. The stepwise temperature range was from  $120^{\circ}\text{C}$  to  $20^{\circ}\text{C}$ . The cooling rate is  $1^{\circ}\text{C}/\text{min}$ . With a fixed measuring point duration of 1minute, 100 measuring point were acquired.

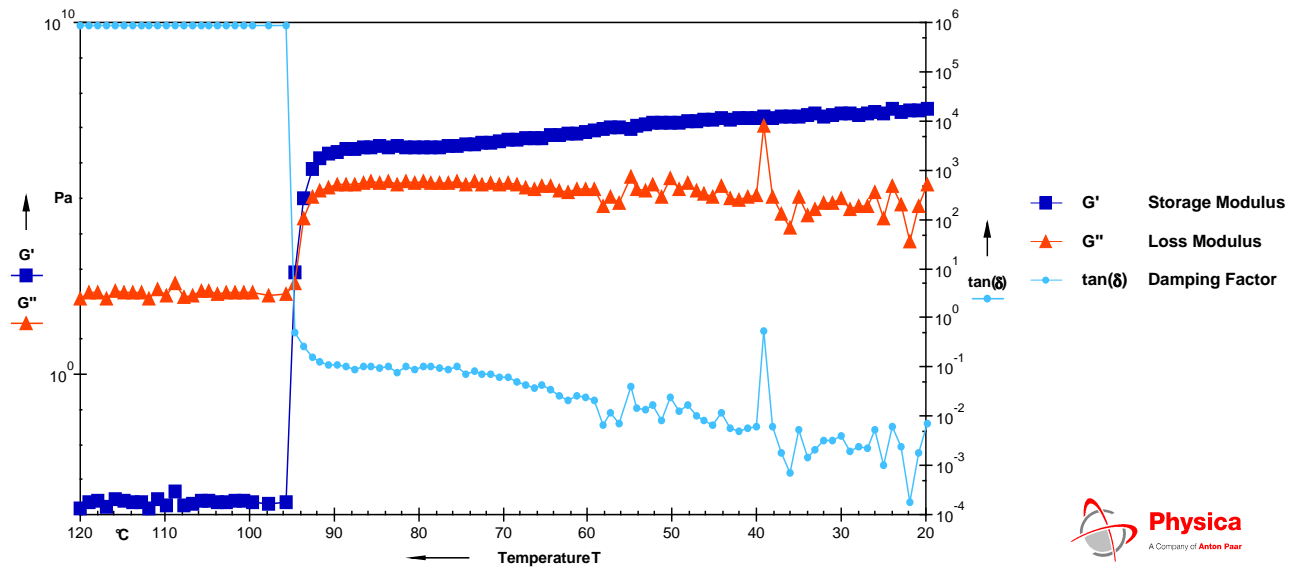

Figure 44 Diagram of temperature ramp oscillation test of experimental wax No.011-3

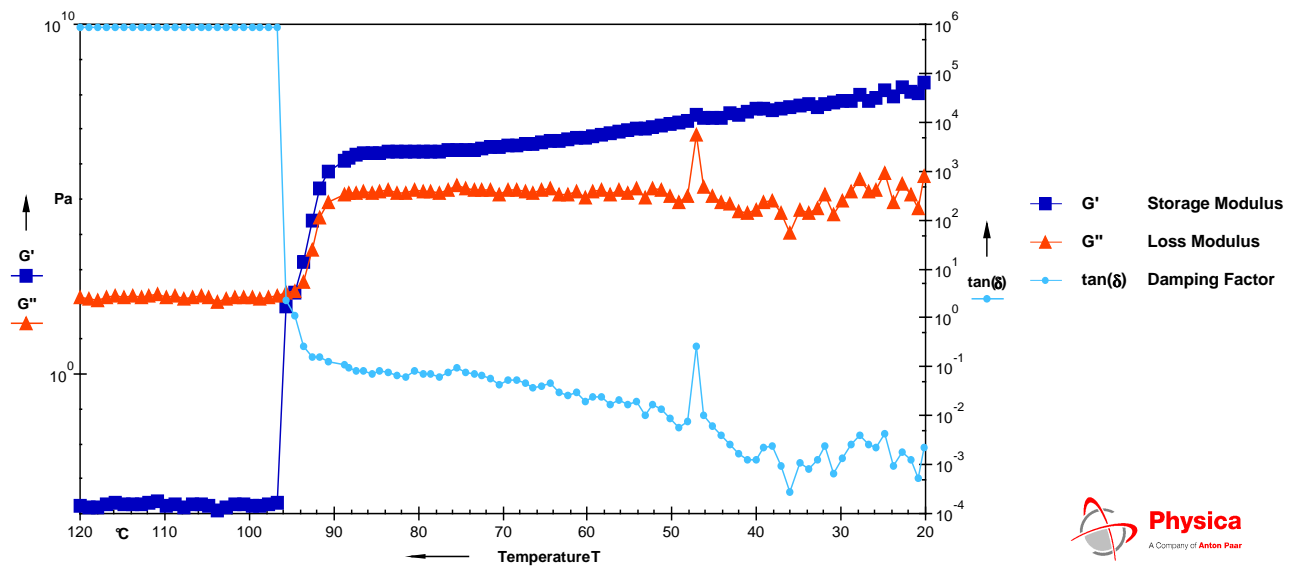

Figure 45 Diagram of temperature ramp oscillation test of experimental wax No.015

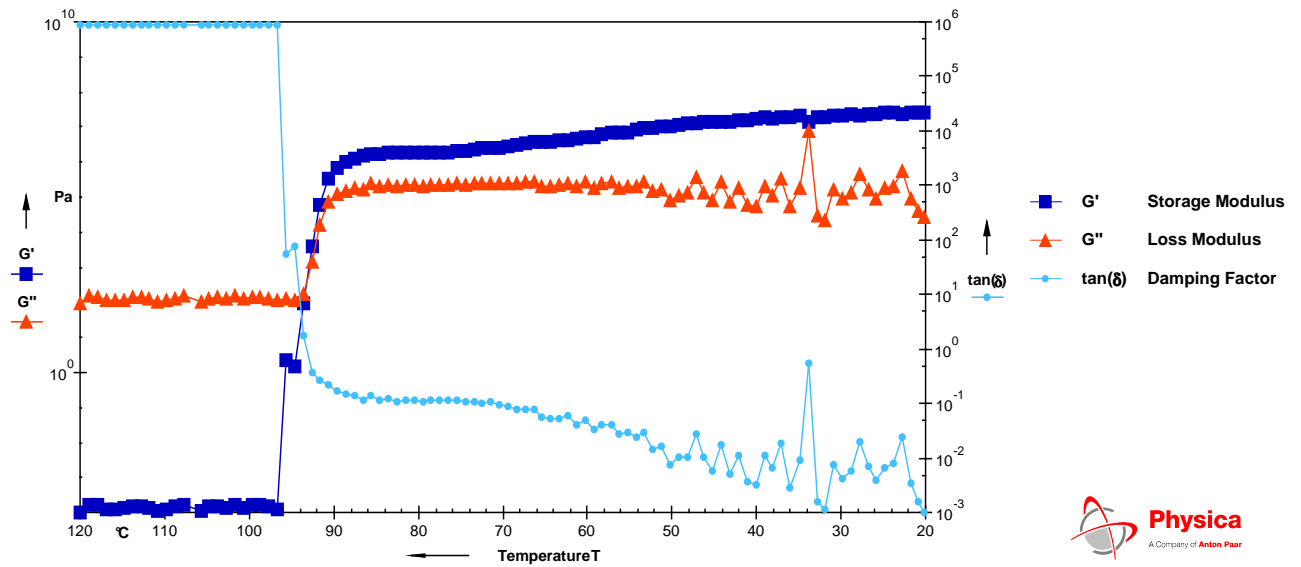

Figure 46 Diagram of temperature ramp oscillation test of experimental wax No.016

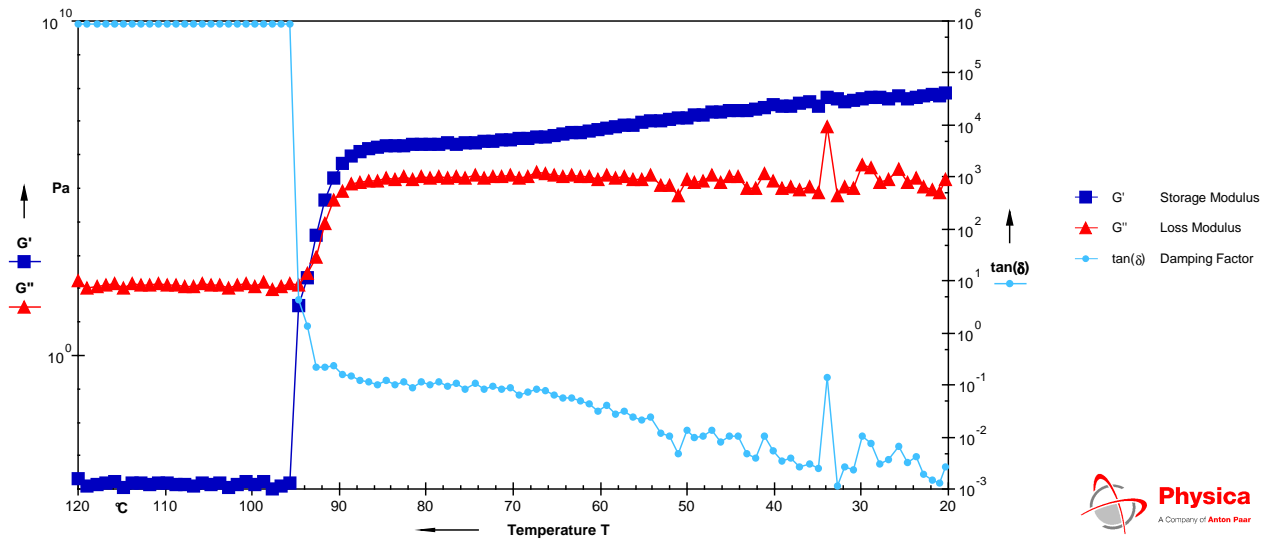

Figure 47 Diagram of temperature ramp oscillation test of experimental wax No.016-1

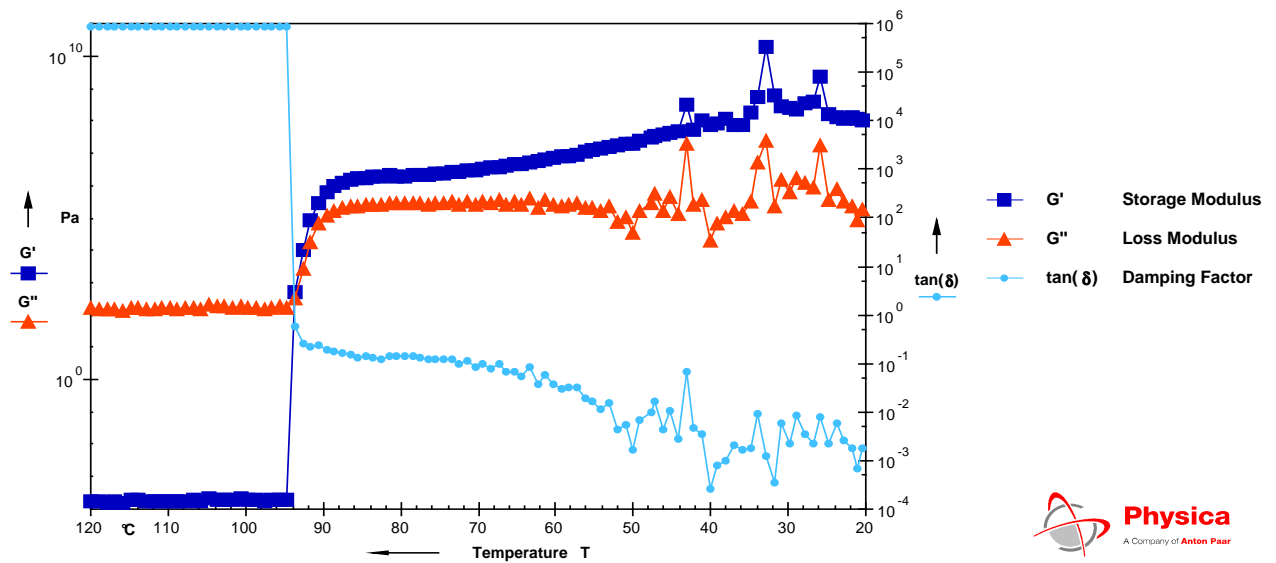

Figure 48 Diagram of temperature ramp oscillation test of experimental wax No.017



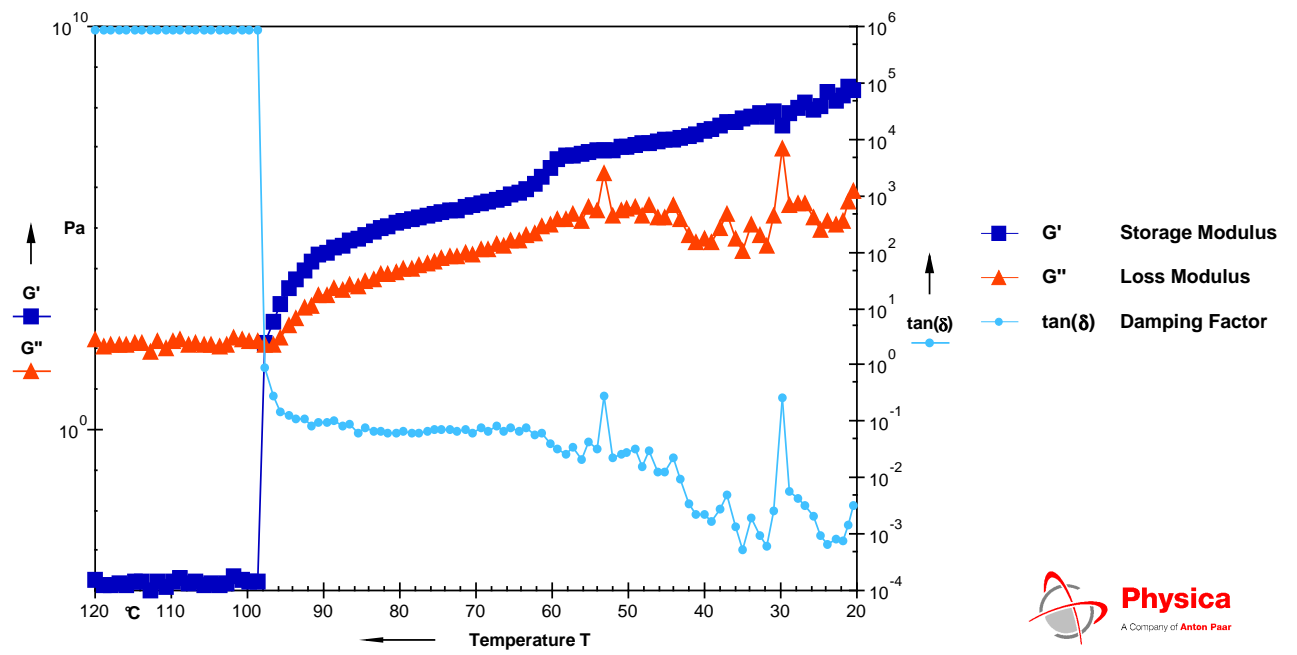

Figure 49 Diagram of temperature ramp oscillation test of experimental wax No.018

## 7.6 Results of amplitude sweep tests(CSD)

The following tables show the LVE-range ( $\gamma_C$ ) and the corresponding storage modulus,  $G'$ , of all dental waxes studied at different temperatures.

Table 3 LVE-range( $\gamma_C$ ), the corresponding storage modulus, $G'$ , at different temperatures of experimental wax No.011-2 (n=3)

Temperature (°C)	LVE-range $\gamma_C$ (%)	Storage modulus $G'$ (Pa)
50	0.259±0.021	2000000±741121
60	0.227±0.081	257933±25281
70	0.059±0.001	97107±12207
80	0.043±0.003	27163±7080
90	0.039±0.001	13997±1887

\* Each value represents the mean ( $\pm$ SD) of three replicates

Table4 LVE-range( $\gamma_C$ ), the corresponding storage modulus, $G'$ , at different temperatures of experimental wax No.011-3 (n=3)

Temperature (°C)	LVE-range $\gamma_C$ (%)	Storage modulus $G'$ (Pa)
50	1.227±0.107	5700333±3007867
60	0.072±0.014	654533±97107
70	0.059±0.013	146100±21703
80	0.044±0.008	40793±9503
90	0.038±0.021	3391±117

\* Each value represents the mean ( $\pm$ SD) of three replicates

Table 5 LVE-range( $\gamma_c$ ), the corresponding storage modulus, $G'$ ,at different temperatures of experimental wax No.015 (n=3)

Temperature (°C)	LVE-range $\gamma_c$ (%)	Storage modulus $G'$ (Pa)
50	0.301±0.081	1000000±339933
60	0.095±0.011	327400±45458
70	0.040±0.010	81513±5086
80	0.039±0.005	16143±3055
90	0.032±0.007	7185±771

\* Each value represents the mean ( $\pm$ SD) of three replicates

Table 6 LVE-range( $\gamma_c$ ), the corresponding storage modulus, $G'$ ,at different temperatures of experimental wax No.016 (n=3)

Temperature (°C)	LVE-range $\gamma_c$ (%)	Storage modulus $G'$ (Pa)
50	0.849±0.260	1573333±94246
60	0.451±0.093	373600±32656
70	0.087±0.009	87677±20337
80	0.044±0.008	22467±3207
90	0.030±0.003	15603±6324

\* Each value represents the mean ( $\pm$ SD) of three replicates

Table 7 LVE-range( $\gamma_c$ ), the corresponding storage modulus, $G'$ ,at different temperatures of experimental No.016 -1 (n=3)

Temperature (°C)	LVE-range $\gamma_c$ (%)	Storage modulus $G'$ (Pa)
50	0.391±0.089	1062733±65961
60	0.318±0.060	316200±62209
70	0.041±0.009	65717±4092
80	0.037±0.001	14757±1223
90	0.049±0.016	7807±1719

\* Each value represents the mean ( $\pm$ SD) of three replicates.

Table 8 LVE-range( $\gamma_c$ ), the corresponding storage modulus, $G'$ ,at different temperatures of experimental wax No.017 (n=3)

Temperature (°C)	LVE-range $\gamma_c$ (%)	Storage modulus $G'$ (Pa)
50	0.256±0.038	1035966±34654
60	0.240±0.030	263233±45971
70	0.051±0.009	43103±7135
80	0.029±0.004	16250±3430
90	0.028±0.006	2424±611

\* Each value represents the mean ( $\pm$ SD) of three replicates.

Table 9 LVE-range( $\gamma_c$ ), the corresponding storage modulus, $G'$ ,at different temperatures of experimental wax No.018 (n=3)

Temperature (°C)	LVE-range $\gamma_c$ (%)	Storage modulus $G'$ (Pa)
50	0.356±0.045	1245000±123596
60	0.284±0.071	318000±47062
70	0.275±0.056	4122±157
80	0.172±0.073	977±172
90	0.118±0.017	198±31

\* Each value represents the mean ( $\pm$ SD) of three replicates.

### 7.7 Results of amplitude sweep tests (CSS)

Table 10 Storage modulus( $G'$ ) and tau value at crossover point of experimental wax No.011-2 at different temperatures (n=3)

Temperature (°C)	tau value (Pa)	Storage modulus $G'$ (Pa)
50	21928±8874	647433±271539
60	2983±411	84040±7971
70	135±31	76420±12732
80	30±10	18080±3778
90	10±3	11268±1508

\* Each value represents the mean ( $\pm$ SD) of three replicates.

Table 11 Storage modulus( $G'$ ) and tau value at crossover point of experimental wax No.011-3 at different temperatures (n=3)

Temperature (°C)	tau value (Pa)	Storage modulus $G'$ (Pa)
50	-----	-----
60	1488±193	363700±53421
70	115±36	144233±26807
80	33±10	33097±8148
90	10±4	1704±350

\* Each value represents the mean ( $\pm$ SD) of three replicates.

Table 12 Storage modulus( $G'$ ) and tau value at crossover point of experimental wax No.015 at different temperatures (n=3)

Temperature (°C)	tau value (Pa)	Storage modulus $G'$ (Pa)
50	13198±2962	370250±82239
60	3027±507	99990±7510
70	60±2	63007±10158
80	20±2	10643±2428
90	11±2	3873±1079

\* Each value represents the mean ( $\pm$ SD) of three replicates.

Table 13 Storage modulus( $G'$ ) and tau value at crossover point of experimental wax No.016 at different temperatures (n=3)

Temperature (°C)	tau value (Pa)	Storage modulus $G'$ (Pa)
50	57014±8906	728603±530026
60	5347±296	112613±9006
70	160±50	73946±14665
80	19±0	17125±2910
90	12±3	8566±3105

\* Each value represents the mean ( $\pm$ SD) of three replicates.

Table 14 Storage modulus( $G'$ ) and tau value at crossover point of experimental wax No.016-1 at different temperatures (n=3)

Temperature (°C)	tau value (Pa)	Storage modulus $G'$ (Pa)
50	15667±490	490267±21122
60	2911±253	96687±9170
70	49±6	59847±4985
80	13±3	11200±991
90	11±2	4663±285

\* Each value represents the mean ( $\pm$ SD) of three replicates.

Table 15 Storage modulus( $G'$ ) and tau value at crossover point of experimental wax No.017 at different temperatures (n=3)

Temperature (°C)	tau value (Pa)	Storage modulus $G'$ (Pa)
50	10833±445	396533±13952
60	2597±80	93927±5536
70	36±11	36305±6252
80	12±3	11974±2753
90	11±0	994±218

\* Each value represents the mean ( $\pm$ SD) of three replicates.

Table 16 Storage modulus( $G'$ ) and tau value at crossover point of experimental wax No.018 at different temperatures (n=3)

Temperature (°C)	tau value (Pa)	Storage modulus $G'$ (Pa)
50	8778±1334	690000±58096
60	211±138	88520±38327
70	30±7	1197±66
80	11±1	236±36
90	3±1	70±27

\* Each value represents the mean ( $\pm$ SD) of three replicates.



## 8. References

1. ADA 24 (1971)  
American Dental Association Specification No. 24 for dental base plate wax  
JADA 82, 603-606
2. ADA 4 (1975)  
American Dental Association Specification No. 4 for dental Inlay Casting wax  
JADA 90, 447-450
3. Almdal, K., Dyre, J., Hvidt, S., Kramer, O. (1993)  
Dynamics during Thermoreversible Gelation of the Polysaccharide Schizophyllan  
Polym. GelsNetw. 1, 5-17
4. ANSI/ADA Specification No. 4 for dental Inlay Casting wax (1994)  
Chicago: American Dental Association
5. Balan, C., Volger, K. W., Kroke, E., Riedel, R. (2000)  
Viscoelastic Properties of Novel Silicon Carbodiimide Gels  
Macromolecules 33, 3404-3408
6. Barnes, H.A., Hutton, J. F. and Walters, K. (1989)  
An Introduction to Rheology  
Elsevier Science Publishing Company INC., New York
7. Barnes, H. A. (2000)  
A handbook of elementary rheology  
University of Wales  
Institute of Non-Newtonian Fluid Mechanics, Aberystwyth
8. Beall, J. R. (1940)  
Revision of American Dental Association Specification No.4 for dental inlay casting wax  
J Am Dent Assoc 27, 1140–1141
9. Berry, G. C. (1999)  
Polymer Rheology: Principles, Techniques and applications  
Carnegie Mellon University Dissertation
10. Bird, R. B., Armstrong, R. C., Hassager, O. (1987)  
Dynamics of Polymeric Liquids 2<sup>th</sup> ed.  
John Wiley & Sons
11. Bower, D. I. (2002)

An Introduction to Polymer Physics  
CAMBRIDGE UNIVERSITY PRESS

12. Caesar, H. H., Ernst, S. (1998)  
Die Nichtmetalle in der Zahntechnik 4<sup>th</sup> ed.  
Verlag Neuer Merkur GmbH, München
13. Ceulemans, J., Ludwig, A. (2002)  
Optimisation of carbomer viscous eye drops : an in vitro experimental  
design approach using rheological techniques  
Europ. J Pharm. Biopharm. 54, 41-50
14. Clark, A. H., Ross-Murphy, S. B. (1987)  
Structural and mechanical Properties of Biopolymer Gels  
Adv. Polym. Sci. 83, 58
15. Collyer, A. A., Clegg, D. W. (1988)  
Rheological Measurement  
Elsevier Science Co., New York
16. Combe, E. C. (1986)  
Notes on dental materials 5<sup>th</sup> ed.  
Churchill Livingstone, London
17. Craig R. G. (1985 )  
Restorative dental materials 7<sup>th</sup> ed.  
St. Louis: Mosby
18. Craig R. G. (1989 )  
Restorative dental materials 8<sup>th</sup> ed.  
St. Louis: Mosby
19. Craig R. G. (1993 )  
Restorative dental materials 9<sup>th</sup> ed.  
St. Louis: Mosby
20. Craig R. G. (1997 )  
Restorative dental materials 10<sup>th</sup> ed.  
St. Louis: Mosby
21. Craig R.G., Eick, J. D. & Peyton F.A. (1965)  
Properties of Natural Waxes Used in Dentistry  
J Dent Res 44, 1308 – 1316
22. Craig, R.G., Eick, J.D. & Peyton, F.A. (1966)  
Flow of binary and Tertiary Mixtures of waxes  
J Dent Res 45, 397-403

23. Craig R. G., Eick, J. D. & Peyton F. A. (1967)  
Strength Properties of Waxes at Various Temperatures and Their  
Practical Application  
J Dent Res 46, 300 – 305
24. Craig, R. G., O' Brien W.J., & Powers, J. M. (1983)  
Dental materials—properties and manipulation 4<sup>th</sup> ed.  
St. Louis: Mosby
25. Craig, R. G., Powers J. M. & Peyton F. A. (1967)  
Differential thermal analysis of commercial and dental waxes.  
J Dent Res 46, 1090-1097
26. Daoud, M. (2000)  
Viscoelasticity near the Sol-Gel Transition  
Macromolecules 33, 3019-3022
27. Darvell B. W., Wong N. B. (1989)  
Viscosity of dental waxes by use of Stokes' Law  
Dent Mater. 16, 176-180
28. Darvell B. W. (2002)  
Materials Science for Dentistry 7<sup>th</sup> ed.  
23 Sha Wan Drive  
Pokfulam  
University of Hongkong
29. Dealy, J. M. (1982)  
Rheometers for Molten Plastic  
Van Nostrand Reinhold Co. New York
30. DIN 53018: Measurement of the dynamic viscosity of newtonian fluids  
using rotational viscometer (1976)
31. Dirksen, L. (1939)  
Composition and properties of a wax for lower impressions  
J Am Dent Assoc 26, 270 – 274
32. Diwan, R., Talic, Y., Omar, N. and Sadig, W. (1997)  
Pattern waxes and inaccuracies in fixed and removable partial denture  
castings  
J Prosthet Dent 77, 553-555
33. Egelanddal, B. , Martinsen, B. & Autio, K. (1995)  
Rheological parameters as predictor of protein functionality A model  
study using myofibrils of different fiber-type composition  
Meat Sci. 39, 97-111

34. Engström, G. & Rigdahl M. (1991)  
On Transition from Linear to Non-linear Viscoelastic Behavior of  
CMC/Latex Coating Colours  
Nordic Pulp Paper Res. J. 2, 63–65
35. Ferry, J. D. (1980)  
Viscoelastic Properties of Polymers 3<sup>th</sup> ed.  
John Wiley & Sons: New York
36. Fielder, H. (1995)  
Mechanical properties of pattern waxes  
43<sup>rd</sup> Annual Technical Meeting INVESTMENT CASTING INSTITUTE
37. Florjancic, U., Zupancic, A., & Zumer. M. (2002)  
Rheological Characterization of Aqueous Polysaccharide Mixtures  
Undergoing Shear  
Chem. Biochem. Eng. Q. 16, 105–118
38. Fredrickson A.G.(1964)  
Principles and applications of rheology  
Englewood Cliffs, NJ  
Prentice-Hall, INC
39. Gasperlin, M., Kristl, J., Smid-Korbar, J.  
Viscoelastic behavior of semi-solid w/o emulsion systems.  
STP Pharma Sci. 7, 158-163
40. George A. Truskey, Fan Yuan and David F. Katz (2002)  
Transport Phenomena in Biological Systems: A Textbook for  
Biomedical Engineers  
Duke University, USA
41. Goodwin, J.W. and Hughes, R.W. (2000)  
Rheology for Chemists: an Introduction  
Royal Society of Chemistry  
Cambridge, UK
42. Grisel, M., Muller, G. (1998)  
Rheological Properties of the Schizophyllan-Borax System  
Macromolecules 31, 4277-4281
43. Gutzow, I., Schmelzer, J. (1995)  
The Vitreous State  
Thermodynamics, Structure, Rheology, and Crystallization  
Springer-Verlag Berlin Heidelberg
44. Hone, J. H. E., Howe, A. M. & Cosgrove, T. (2000)  
A Rheological and Small-Angle Neutron Scattering Study of the

Structure of Gelatin/Polyelectrolyte Complexes under Shear  
Macromolecules 33, 1199-1205

45. Hornsby, P. R. (1999)  
Rheology, Compounding and Processing of Filled Thermoplastics  
Advances in Polymer Science  
Springer-Verlag Heidelberg, Germany
46. Hosney, R.C. (1994)  
Principles of Cereal Science and Technology 2<sup>th</sup> ed.  
American Association Cereal Chemists, Inc.  
St. Paul, Minnesota, USA
47. ISO 3201 (1975)  
Sodium and potassium silicates for industrial use –  
Determination of iron content -- 1,10- Phenanthroline photometric  
method  
International Organization for Standardization, Geneva
48. ISO 3219 (1993)  
Plastics-Polymers / resins in the liquid state or as emulsions or  
dispersions-----Determination of viscosity using a rotational viscometer  
with defined shear rate  
International Organization for Standardization, Geneva
49. ISO/DIS 1561 (1994)  
Revision of first edition (ISO 1561:1975), Dental inlay casting wax.  
International Organization for Standardization, Geneva
50. ISO Standard 1561 (1975)  
Specification of Dental Inlay Casting Wax  
International Organization for Standardization, Geneva
51. ISO TC 106/ADA No. 24 (1996)  
Dental Baseplate/Modelling Wax (draft).  
International Organization for Standardization, Geneva
52. Ito, M. ; Kuroiwa, A. , Nagasawa, S. *et al.* (2002)  
Effect of wax melting range and investment liquid concentration on the  
accuracy of a three-quarter crown casting  
The Journal of Prosthetic Dentistry 87, 57-61
53. Ito, M., Yamagishi, T. , Oshida, Y. *et al.* (1996)  
Effect of selected physical properties of waxes on investments and  
casting shrinkage  
J Prosthet Dent. 75, 211-216
54. Ivanovszky L. (1941)

- New standards for petroleum waxes  
Petroleum (London) 4, 108–109
55. Kobayashi, M., Ishikawa, S., Sameijima, M. (1982)  
Application of nonlinear viscoelastic analysis by the oscillation method to some pharmaceutical ointments in the Japanese Pharmacopeia  
Chem. Pharm. Bull. 30, 4468-4478
  56. Korhonen, M., Lehtonen, J., Hellen, L., Hirvonen, J., Yliruusi, J. (2002)  
Rheological properties of three component creams containing sorbitan monoesters as surfactants  
Inter. J of Pharm. 247, 103 –114
  57. Kotsiomiti, E., McCabe, JF. (1995)  
Stability of dental waxes following repeated heatings  
J Oral Rehabil 22, 135-43
  58. Kotsiomiti, E., McCabe, JF. (1996)  
Waxes for functional impressions  
J of Oral Rehabilitation 23, 114-120
  59. Lapasin, R., Prici, S. (1995)  
Rheology of Industrial Polysaccharides: Theory and Applications,  
Blackie Academic & Professional, Glasgow
  60. Lapasin, R., Prici, S. (1998)  
In Progress and Trends in Rheology V  
Springer: Berlin
  61. Larson, R. G. (1999)  
In The Structure and Rheology of Complex Fluids  
Oxford University Press: New York
  62. Lasater, R. L. (1940)  
Control of wax distortion by manipulation  
J Am Dent Assoc 27, 518–24
  63. Lauger, J., Huck, S. (2000)  
Real controlled stress and controlled strain experiments with the same rheometer  
Proceedings of the 11th International Congress on Rheology  
Cambridge
  64. Lauger, J., Raffer, G. (2001)  
Physica Advanced Peltier System ptd 150 (pat. pent.) Making the Temperature Control with a Peltier System Accurate  
Applied Rheology 281-283

65. Mackley, M. R., Marshall, R. T. J., Smeulders, J. B. A. F. & Zhao, F. D. (1994)  
The rheological characterization of polymeric and colloidal fluids  
Chem Eng Sci 49, 2551-2565
66. Macosko, C. W. (1994)  
Rheology: Principles, Measurements and Applications  
Wiley-VCH Publishers, New York
67. Malkin A.Y. (1994)  
Rheology - Fundamentals (Fundamental Topics in Rheology)  
ChemTec Publishing
68. Martin, A., Swarbrick, J. & Cammarata, A. (1983)  
Physical Pharmacy  
Physical Chemical Principles in the Pharmaceutical Sciences 3<sup>th</sup> ed.  
Chapter19: Rheology  
Lea & Febiger, Philadelphia, USA
69. Matricardi, P., Dentini, M., Crescenzi, V. (1993)  
Rheological Gel-Point Determination for a Polysaccharide System  
Undergoing chemical Cross-Linking  
Macromolecules 26, 4386-4387
70. McCrorie J. W. (1974)  
Some physical properties of dental modelling waxes and their main  
constituents  
J of Oral Rehabilitation 1, 29
71. McCrorie J. W. (1982)  
Corrective impression waxes: a simple formula  
Brit Dent J 152, 95
72. McMillan, L. C. (1998)  
Aspects of the rheology of dental waxes  
*PhD Thesis* University of Hong Kong
73. McMillan, L.C., Darvell B.W. (2000)  
Rheology of dental waxes  
Dent Mater 16, 337-350
74. Niles J. C., Anibarro M. & Fielder H. (2002)  
Wax Characterization  
INVESTMENT CASTING INSTITUTE  
50th TECHNICAL CONFERENCE & EXPO 2002  
Chicago
75. O' Brien W. J. (2002)

Dental Materials and Their Selection 3<sup>th</sup> ed  
Quintessence Publishing Co. Inc.

76. Ohnmacht, P. (1966)  
Zahnärztliche Wachse  
In: Eichner, K. und Kappert, H.F.  
Zahnärztliche Werkstoffe und ihre Verarbeitung  
Hüthig, Heidelberg
77. Ohnmacht, P., Hasert, G. und Schneiderbanger, T. (2001)  
Dentale Wachse  
Quintessenz Zahntech 27, 63-74
78. Partington, J. R. (1951)  
An Advanced Treatise on Physical Chemistry  
Longmans, London
79. Phillips R.W. (1982 )  
Skinner's science of dental materials 8<sup>th</sup> ed.  
WB Saunders, Philadelphia
80. Phuapradit, W., Shah, N. H., Lou, Y., Kundu, S.& Infeld, M.H. (2002)  
Critical processing factors affecting rheological behavior of a wax based  
formulation  
Europ. J Pharm. Biopharm. 53, 175-179
81. Plazek, D. J. (1980)  
Viscoelastic and steady-state rheological response  
In Methods of experimental Physics; R. A. Fava, ed.; Vol.16C; Chapt 11.  
Academic Press; New York
82. Powers, J.M. & Craig, R.G. (1978)  
Thermal analysis of dental impression waxes  
J. Dent. Res. 57, 37
83. Raghavan, S. R.; Khan, S. A. J. (1995)  
Shear-induced microstructural changes in flocculated suspensions of  
Fumed silica  
Rheol. 39, 1311-1325
84. Ray, N. (2003)  
DENTAL MATERIALS SCIENCE  
University Dental School & Hospital,  
Wilton, Cork, IRELAND
85. Reiber, Th., Hupfauf, S. (1990)  
Zum thermischen Dimensionsverhalten zahnärztlicher Registrierwachse  
ZWR 99, 551-553



86. Sayers, R. (1983)  
Wax—An Introduction  
London: Gentry Books
87. Schoff, C. K., Kamarchik, P. (1993)  
Rheological Measurements  
In Kirk-Othmer Encyclopedia of Chemical Technology  
Wiley: New York
88. Smith, D.C., Williams, D. F. (1982)  
Biocompatibility of Dental Materials Volume □  
Biocompatibility of Prosthodontic materials  
CRC Press, Inc.  
Boca Raton, Florida
89. Stanford, J. W., Weigel, K. V., Paffenbarger, G. C. (1961)  
Second revision of American Dental Association Specification No. 4 for  
Dental Inlay Casting Wax  
J Am Dent Assoc 62, 59–67
90. Tanaka, F. (1998)  
Polymer-Surfactant Interaction in Thermoreversible Gels  
Macromolecules 31, 384-393
91. Tanner, R. I. (2000)  
Engineering Rheology 2<sup>th</sup> ed.  
Oxford Engineering Science Series  
Oxford University Press, New York
92. Taylor, N. O. , Paffenbarger, G. C. , Sweeney, W. T. (1931)  
A specification for inlay casting wax  
J Am Dent Assoc 18, 40–52
93. Thomas Mezger (2002)  
The Rheology Handbook  
Vincentz Verlag, Hannover, Germany
94. Toyochi Tanaka. (2000)  
Experimental methods in polymer science: Modern methods in polymer  
research and technology  
Academic Press
95. Tschoegl, N. W. (1989)  
The Phenomenological Theory of Linear Viscoelastic Behaviour  
An Introduction  
Springer-Verlag, Berlin

96. UDS 200, Instrument Manual, (2003)  
Physica Messtechnik, Stuttgart, Germany
97. UDS 200 Operating manual (2003)  
Universal Dynamic Spectrometer PHYSICA UDS 200  
Physica Messtechnik GmbH, Stuttgart, Germany
98. US 200 - Device Drivers MC 200 / DSR 4000 Instruction Manual (2003)  
Physica Messtechnik GmbH, Stuttgart, Germany
99. Universal Software US200, Instruction Manual, (2003)  
Physica Messtechnik GmbH, Stuttgart, Germany
100. Visessanguan, W., Ogawa, M., Nakai, S., An, H. (2000)  
Physicochemical changes and mechanism of heat-induced gelation of  
arrowtooth flounder myosin.  
J. Agric. Food Chem. 48, 1016-1023
101. Walters, K. (1975)  
Rheometry  
Chapman and Hall
102. Watanabe K. (1981)  
Mechanism of the anisotropic dimensional change of the wax pattern  
prepared by the softened wax technique  
J Jap Soc Dent Appar Mater 22, 63–69
103. Water, M., Jagger, R., Williams, K., & Jerolimov, V. (1996)  
Dynamic mechanical thermal analysis of denture soft materials  
Biomaterials 17, 1627-1630
104. Website: [www.physica.de](http://www.physica.de)
105. Website: [www.rheoNet.de](http://www.rheoNet.de)
106. Weipert, D., Tscheuschner, H.-D., Windhab, E. (1993)  
Rheology der Lebensmittel  
Behr's: Hamburg
107. Winter, H. H., Chambon, F. (1986)  
Analysis of Linear Viscoelasticity of a Crosslinking Polymer at the Gel  
Point  
J Rheol 30:367–382
108. Winter, H. H. (1989)  
In Encyclopedia of Polymer Science and Engineering  
John Wiley & Sons: New York

109. Wunderlich, B. (1986)  
Thermal analysis Encyclopedia of Materials Science and Engineering  
Oxford: Pergamon
110. Yoon, P. J., Han, C. D. (2000)  
Effect of Thermal History on the Rheological Behavior of Thermoplastic  
Polyurethanes  
Macromolecules 33, 2171-2183

## 9. Acknowledgements

First, I deeply appreciate Prof. Dr. Jürgen Geis-Gerstorfer to give me the interesting theme. Without his powerful support and professional guidance, this dissertation would not have been possible.

I wish to express my heartfelt appreciations to Prof. Dr. Heiner Weber who gave me the opportunity of 'Promotion' in the Dental School, University of Tübingen.

I would like to acknowledge Mr. Thomas Mezger, Mr. J. Utz, Ms. C. Schönhaar and Ms. M. Bernzen of Physica Messtechnik GmbH. Their lectures on the rheological theories, the newest Software and suggestions have taken a great role in my researches.

In addition, I owe Ms. Hassert and Mr. Ohnmacht, Dentaforum, GmbH, for the supporting materials and informations.

I sincerely wish to express my deepest gratitude to Dr. Xiaolong Zhu for his unending encouragement.

I also appreciate Mr. Günter Wedenig for the technical supportings.

Finally, I am so grateful for the friendship and kindness of all my colleagues in Sektion MWT (Medizinische Werkstoffkunde und Technologie) and the department of prosthodontics.

